

CHOOSE SAFE PRODUCTS FOR CERAMIC ARTS

AMACO® made the first Lead Free glaze for schools and manufactures Lead Free Glaze colors with "AP" formulations for use in grades K-12. We also make a small number of Lead Free glazes for grades 7 and above that are designated "CL" for Cautions Labeling, which gives safety information regarding other ingredients.

AMACO® ceramic clays are made with safe "AP" formulations in moist form.

AMACO® designs and manufactures brent® pottery wheels for school and studio use.

brent® wheels are the "gold standard" in wheel engineering with a 10-year warranty to back up optimal torque, complete control, and quiet operation.

EXCEL® round kilns come in a variety of sizes to meet your budget.

With most equipment purchases, you automatically receive a rebate of FREE glazes or underglazes.

FIRING CLAYS
PAGES 5-8



LEAD FREE UNDERGLAZES
PAGES 9-15



LEAD FREE GLAZES
PAGES 16-36



WHEELS
PAGES 37-49



SLAB ROLLERS
PAGES 42-43



CARTS
PAGES 45-47



KILNS
PAGES 50-75



TOOLS AND BRUSHES
PAGES 76-81

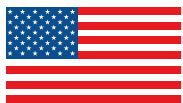

We certify that we ship only lead free products in compliance with the Consumer Product Safety Improvement Act of 2008.



As a founding member of the Art & Creative Materials Institute, we guarantee that all product formulations are tested by toxicologists at Duke University and exceed governmental requirements for safe product formulations.



CHOOSE SAFE PRODUCTS FOR MODELING AND SCULPTING

AMACO® makes unique modeling and sculpting materials that are enduring classics in schools and studios.

At AMACO®, our customers teach art and pass on a legacy of creativity. We know you personally *'support the arts'* with your own two hands and many times your own wallet. With a limited art budget, you must be able to offer your students safe, quality products with consistent, reliable results. That's why we are not a trendy company, but a tried 'n true resource for art educators.

Real trendsetting happens in the creative process, in the classroom or studio! Our job is to ensure successful art experiences, so that your legacy and ours endures. Our company is family-owned and operated since 1919. We're here to support you.

SELF-HARDENING CLAYS
PAGES 82



AIR DRY CLAYS
PAGES 83



MODELING CLAYS
PAGES 84



MODELING COMPOUNDS
PAGES 85



SCULPTING MATERIALS
PAGES 85



MOLDMAKING SUPPLIES
PAGE 85



METALLIC FINISHES
PAGE 87

TABLE OF CONTENTS

NEW! UNDERGLAZE AND GLAZE COLORS FOR 2024

VELVET UNDERGLAZE

FOUR NEW COLORS
(AVAILABLE IN 2 OZ. AND PINTS)

The Art & Creative Materials Institute AP (Approved Product) seal certifies this product to be safe for use by all ages.



V-311 [O] [P]
Nectar



V-330 [O] [P]
Indigo



V-329 [O] [P]
Sea Glass

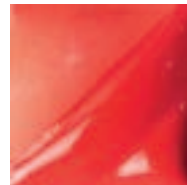

V-392 [O] [P]
Blood Orange

CELADON GLAZES

FIVE NEW COLORS
(AVAILABLE IN PINTS)

The Art & Creative Materials Institute AP (Approved Product) seal certifies this product to be safe for use by all ages.



C-24 [TP] [P]
Succulent

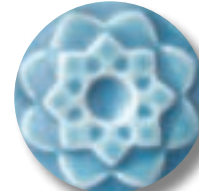

C-26 [TP] [P]
Lagoon

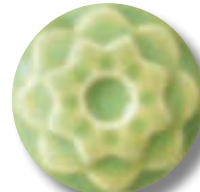

C-42 [TP] [P]
Saguaro

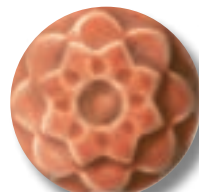

C-33 [TP] [P]
Sandalwood

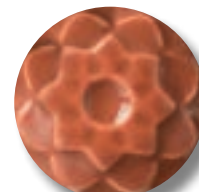

C-52 [TP] [P]
Red Rock

SATIN MATTE GLAZES

SIX NEW COLORS
(AVAILABLE IN PINTS)

The Art & Creative Materials Institute AP (Approved Product) seal certifies this product to be safe for use by all ages.



SM-2 [O] [P]
Stone



SM-3 [O] [P]
Marble



SM-24 [O] [P]
Seafoam



SM-46 [O] [P]
Moss



SM-53 [O] [P]
Cayenne



SM-60 [O] [P]
Goldenrod

NEW! LIQUID BRUSHING GLAZE SERIES FOR 2024

POTTER'S CHOICE FLUX-PCF LIQUID BRUSHING GLAZES

SIX COLORS
(AVAILABLE IN PINTS AND SOME COLORS IN GALLONS)

The Art & Creative Materials Institute AP (Approved Product) seal certifies this product to be safe for use by all ages.



PCF-3 [O] (P)
Midnight Run

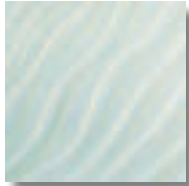

PCF-19 [TL] (P)
Cirrus Flow

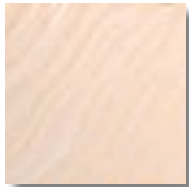

PCF-54 [TL] (P)
Flux Blossom

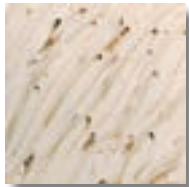

PCF-74 [TL] (P)
River Birch

The CL seal restricts this product from children under the age of 13. Older users must follow all cautionary labeling.

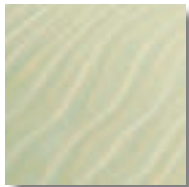

PCF-18 [TL] (P)
Honeydew

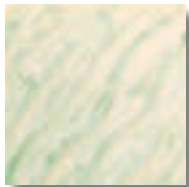

PCF-75 [TL] (P)
Moss Mist

See pages 30-31 for more information

COSMOS-CO LIQUID BRUSHING GLAZES

FIVE COLORS
(AVAILABLE IN PINTS)

The Art & Creative Materials Institute AP (Approved Product) seal certifies this product to be safe for use by all ages.

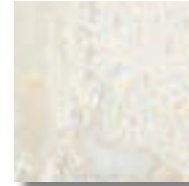

CO-6 [TL] (P)*
Supernova

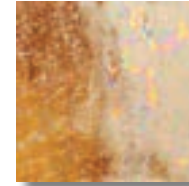

CO-7 [O] (P)*
Solar Flare



CO-8 [O] (P)*
Dark Star



CO-13 [O] (P)*
Mars Crystal



CO-14 [O] (P)*
Solar Rainbow

*Food safe but not recommended for food surfaces due to durability.

See pages 30-31 for more information

For a list of distributor's, visit amaco.com

NEW! DRY DIPPING GLAZE SERIES FOR 2024

DIPPING & LAYERING—DL DRY DIPPING GLAZES

EIGHT COLORS

(MAKES APPROXIMATELY 1.5 GALLONS OF DIPPING GLAZE)

The CL seal restricts this product from children under the age of 13.
Older users must follow all cautionary labeling.



DL-1 [O] (P)
Ebony

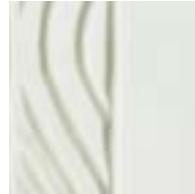

DL-11 [O] (P)
Enamel White

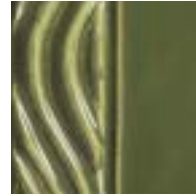

DL-42 [O] (P)
River Moss



DL-70 [O] (P)
Oxblood

These colors do not carry any seal but include
the wording "Conforms to ASTM D-4236".

Conforms to
ASTM D-4236



DL-20 [O] (P)
Floating Blue



DL-23 [O] (P)
Ultramarine



DL-33 [O] (P)
Low Tide



DL-60 [O] (P)
Honeycomb

AMACO® LOW FIRE CERAMIC CLAYS



FIRING CLAYS



Moist



Conforms to
ASTM D-4236

Moist



Conforms to
ASTM D-4236

WHITE ART CLAY NO. 25

- Fires off-white after bisque firing to Cone 04 for optimal glaze surface
- Opaque and transparent glazes and underglazes retain their true color and brilliance
- Extreme plasticity makes it easy to throw large pieces
- Superior versatility makes it ideal for all skill levels and Cone 05 glazes and underglazes

Packaging for Moist Clay: One or two 25 lb. blocks in polyethylene bags packed in a carton.

45014X No. 25-M Moist, 25 lbs. **\$28.50** SSU=90
45015Y No. 25-M Moist, 50 lbs. **\$44.00** SSU=40

SEDONA RED CLAY NO. 67

- Rich red color before and after firing
- Excellent plasticity for all hand methods of modeling: slab, push and pull, coil, sculpture, and wheel throwing
- Will not slump or warp at low temperatures like other red clays

Packaging: Moist: Two 25 lb. blocks in polyethylene bags packed in a 50 lb. carton.

45131A No. 67-M Moist, 50 lbs. **\$44.00** SSU=40

| Moist Form | Color Range | Suggested Firing Temperature | | | Suggested Glazes | Shrinkage | Absorption |
|--|------------------------|------------------------------|-----------------------------|---|---------------------|-----------------|------------------|
| | | Bisque | Glaze | Alternate | | | |
|  Conforms to ASTM D-4236 | Cone 05-3 Off-White | Cone 04 1971°F 1077°C | Cone 05 1911°F 1044°C | Cone 05-3 1911°-2138°F 1044°-1170°C | Low Fire Cone 05 | Cone 04 6.3% | Cone 04 13.7% |

| Moist Form | Color Range | Suggested Firing Temperature | | | Suggested Glazes | Shrinkage | Absorption |
|--|--|------------------------------|-----------------------------|--|---------------------|------------------|-----------------|
| | | Bisque | Glaze | Alternate | | | |
|  Conforms to ASTM D-4236 | Cone 05 Rich Red Cone 02 Rich Red Brown | Cone 04 1971°F 1077°C | Cone 05 1911°F 1044°C | Cone 05-02 1911°-2052°F 1044°-1122°C | Low Fire Cone 05 | Cone 05 11.7% | Cone 02 9.2% |
| | | | | | | Cone 02 13% | Cone 04 7% |

Clay in moist form presents no hazard.



FIRING CLAYS

AMACO® MID/HIGH FIRE CERAMIC CLAYS



Moist



Conforms to
ASTM D-4236

TERRA COTTA STONEWARE CLAY NO. 77

- Terra cotta colored bisque that's suitable for all glazes and underglazes
- Mixture of finely ground clays, medium ground clays, and grog make this an excellent red clay for wide firing range including large scale Raku pieces
- Coarse formula allows air to release easily so large size hand built or wheel thrown pieces will not crack and tiles will fire flat without warping

Packaging: Two moist 25 lb. blocks in polyethylene bags packed in a 50 lb. carton.

45143N No. 77-M Moist, 50 lbs.\$52.00 SSU=40

| Moist Form | Color Range | Suggested Firing Temperature | | | Suggested Glazes | Shrinkage | Absorption |
|---|-------------|------------------------------|----------------------------|---|------------------|------------------|----------------|
| | | Bisque | Glaze | Alternate | | | |
|  Cone 05 Terra Cotta Cone 5 Rich Red Brown | | Cone 04 1971°F 1077°C | Cone 5 2205°F 1207°C | Cone 05-5 1911°-2205°F 1044°-1207°C | Cone 5 | Cone 04 6.75% | Cone 04 9% |
| | | | | | | Cone 5 10.5% | Cone 5 0.9% |



Moist



Conforms to
ASTM D-4236

BUFF STONEWARE CLAY NO. 46

- Excellent for making durable dishes, sculpture, planters, patio vases, and other utility and decorative ware
- Bisque is very dense and semi-vitreous and is a creamy tan at Cone 5 and soft gray at Cone 10
- Can be bisque fired at Cone 04 on which high fire glazes are easy to apply or can be fired to Cone 5 and low fire glazes applied

Packaging: Moist: Two moist 25 lb. blocks in polyethylene bags packed in a 50 lb. carton.

45083X No. 46-M Moist, 50 lbs.\$44.00 SSU=40

| Moist Form | Color Range | Suggested Firing Temperature | | | Suggested Glazes | Shrinkage | Absorption |
|---|-------------|------------------------------|----------------------------|---|------------------|------------------|----------------|
| | | Bisque | Glaze | Alternate | | | |
|  Cone 5 Creamy Tan Cone 10 Soft Gray | | Cone 04 1971°F 1077°C | Cone 5 2205°F 1207°C | Cone 5-10 2205°-2381°F 1207°-1305°C | Cone 5 | Cone 5 12% | Cone 5 1.8% |
| | | | | | | Cone 10 13.2% | Cone 10 0% |

AMACO® MID/HIGH FIRE CERAMIC CLAYS



FIRING CLAYS



Moist



Conforms to
ASTM D-4236

Moist



Conforms to
ASTM D-4236

WHITE STONEWARE NO. 38

- Formulated from choice clays for plasticity and whiteness, plus fire-clay for more body
- Contains no grog, yet has the strength for throwing large pieces, slab rolling and hand building
- Underglazes and engobes fire with little distortion of color on this clay body
- Like porcelain, expect some shrinkage when applying handles or connecting pieces. Connect separate pieces when each contains similar moisture.

Packaging: Two moist 25 lb. blocks in polyethylene bags packed in a 50 lb. carton.

45047J No. 38-M Moist, 50 lbs. **\$44.00** SSU=40

A-MIX WHITE STONEWARE NO. 11

- Off-white plastic clay formulated to be versatile and strong
- Ideally suited for throwing and all types of hand-building
- Great green strength and fires equally strong
- Excellent clay body for use with almost any glaze; particularly nice for showing off transparent glazes
- Low iron content makes it ideal for avoiding interaction with glazes

Packaging: Two moist 25 lb. blocks in polyethylene bags packed in a 50 lb. carton.

45045M No. 11-M Moist, 50 lbs. **\$44.00** SSU=40

| Moist Form | Color Range | Suggested Firing Temperature | | | Suggested Glazes | Shrinkage | Absorption |
|---|---|------------------------------|-----------------------------|---|------------------|----------------|-----------------|
| | | Bisque | Glaze | Alternate | | | |
|  Conforms to ASTM D-4236 | White (oxid.) Gray (reduct.) both Peppered w/Gray Specks | Cone 04 1971°F 1077°C | Cone 10 2381°F 1305°C | Cone 5-10 2205°-2381°F 1207°-1305°C | Cone 10 | Cone 5 13% | Cone 5 7% |
| | | | | | | Cone 10 15% | Cone 10 1.4% |

| Moist Form | Color Range | Suggested Firing Temperature | | | Suggested Glazes | Shrinkage | Absorption |
|---|---|------------------------------|----------------------------|-----------------------------|------------------|------------------|-----------------|
| | | Bisque | Glaze | Alternate | | | |
|  Conforms to ASTM D-4236 | Cone 5 Off-White Cone 10 Dark Buff | Cone 04 1971°F 1077°C | Cone 5 2205°F 1207°C | Cone 10 2381°F 1305°C | Cone 5 | Cone 5 11.2% | Cone 5 7.03% |
| | | | | | | Cone 10 12.9% | Cone 10 1.6% |

Clay in moist form presents no hazard.

AMACO® CLAYS SUPPLIES



Conforms to
ASTM D-4236

AMACO® RUBBER LATEX

Make castings quickly and accurately by applying white liquid latex over original models. Molds will be tough, flexible, and withstand 200-300 castings. Dried, molds have a weight loss of 42%.

The CL seal restricts this product from children under the age of 13.
Older users must follow all cautionary labeling.

41391K Rubber Latex, 1 Pint jar**\$36.75**
SSU=12, Shipping Weight 21 lbs.

BISQUE FIX

This white paste is an excellent mending material for bisque that can be used to bond pieces together or fill up broken cavities. Can be colored to match bisque using metal oxides or ceramic stains. Fire to the temperature of the clay and glaze that you are using—up to Cone 10 (2381°F, 1305°C).

The CL seal restricts this product from children under the age of 13.
Older users must follow all cautionary labeling.



Conforms to
ASTM D-4236

28897B 4 fl. oz. jar***\$30.75**
SSU=6, Shipping Weight 3 lbs.

***WARNING:** Bisque Fix can expose you to chemicals including Ceramic fibers (airborne particles of respirable size), which are known to the State of California to cause cancer. For more information go to www.P65Warnings.ca.gov.



POLYETHYLENE PLASTIC BAGS

Strong, durable polyethylene plastic bags have many uses. Mix water with dry clay, store moist clay, keep unfinished pieces moist, and cover finished pieces for slow, safe drying.

11037P 20" x 24" 12 per package**\$7.90**
SSU=12



AMACO CLASSROOM HAS CLAY RESOURCES!

STAGES OF CLAY

A short presentation on the five stages of ceramic clay, perfect for sharing with your classroom!

CLAY STORAGE

A short video which shows how to properly store clay so it remains workable when you need it.

RECYCLING CLAY

From wet clay to bone dry clay, this short video shows you four ways you can recycle that clay.

ALSO CHECK OUT THE CERAMIC CURRICULUM AND PROJECTS!

VISIT TODAY!



Scan me to go to
AMACOClassroom.com

LEAD FREE CONE 5/10 VELVETS TEMPERATURE/COLOR VARIATION CHART

This chart shows how AMACO® Velvet underglazes look when fired to Cone 5 or 10 on AMACO® 38-M White Stoneware Clay. Use this chart as a guide when selecting underglazes for use on stoneware or porcelain.

UNDERGLAZES

| | | | | | | | |
|---------------------------|------------------------|-------------------------|-----------------------------------|--------------------------------|-----------------------------|--------------------|--------------------------|
| V-301 Ivory Beige | V-303 Terra Cotta | V-304 Straw | V-308 Yellow | V-309 Deep Yellow | NEW! V-311 Nectar | V-313 Red Brown | V-314 Chocolate Brown |
| V-315 Peach | V-317 Coral | V-318 Rose | V-320 Lavender | V-321 Lilac | V-322 Purple | V-323 Salmon | V-324 Blush |
| V-325 Baby Blue | V-326 Medium Blue | V-327 Turquoise Blue | V-328 Iceberg Blue | NEW! V-329 Sea Glass | NEW! V-330 Indigo | V-332 Teal Blue | V-333 Avocado |
| V-336 Royal Blue | V-341 Blue Green | V-343 Chartreuse | V-345 Light Green | V-347 Pistachio | V-349 Cactus | V-350 Orange | V-353 Dark Green |
| V-356 Pearl Gray | V-359 Ultra White | V-360 White | V-361 Jet Black | V-362 Ultra Black | V-363 Morning Fog | V-364 Elephant | V-365 Slate |
| V-366 Teddy Bear Brown | V-370 Velour Black | V-375 Maroon | V-376 Hunter Green | V-379 Ultra Violet | V-380 Violet | V-381 Amethyst | V-382 Red |
| V-383 Light Red | V-384 Real Orange | V-385 Cinnamon | V-386 Electric Blue | V-387 Bright Red | V-388 Radiant Red | | |
| V-389 Flame Orange | V-390 Bright Orange | V-391 Intense Yellow | NEW! V-392 Blood Orange | | | | |

Velvet Underglazes fired on AMACO® 38-M White Stoneware Clay bisque buttons. One half of each button is shown with HF-9 Zinc-Free Clear Glaze.



LEAD FREE CONE 05 VELVET (V) UNDERGLAZES FOR BISQUE, GREENWARE AND WET CLAY



Conforms to
ASTM D-4236

| | | | | | | | | | | |
|---------------------------|---------------|----------------|---------------------------|---------------|---------------------------|---------------|-----------------|------------------|---------------|---------------------------|
| | | | | | | | | | | |
| V-301 [O] (S) | V-303 [O] (S) | V-304 [O] (S) | V-308 [O] (S) | V-309 [O] (S) | NEW! V-311 [O] (S) | V-313 [O] (S) | V-314 [O] (S) | V-315 [O] (S) | V-317 [O] (S) | |
| Ivory Beige | Terra Cotta | Straw | Yellow | Deep Yellow | Nectar | Red Brown | Chocolate Brown | Peach | Coral | |
| | | | | | | | | | | |
| V-318 [O] (S) | V-320 [O] (S) | V-321 [O] (S) | V-322 [O] (S) | V-323 [O] (S) | V-324 [O] (S) | V-325 [O] (S) | V-326 [O] (S) | V-327 [O] (S) | V-328 [O] (S) | NEW! V-329 [O] (S) |
| Rose | Lavender | Lilac | Purple | Salmon | Blush | Baby Blue | Medium Blue | Turquoise Blue | Iceberg Blue | Sea Glass |
| | | | | | | | | | | |
| NEW! V-330 [O] (S) | V-332 [O] (S) | V-333 [O] (S) | V-336 [O] (S) | V-341 [O] (S) | V-343 [O] (S) | V-345 [O] (S) | V-347 [O] (S) | V-349 [O] (S) | V-350 [O] (S) | V-353 [O] (S) |
| Indigo | Teal Blue | Avocado | Royal Blue | Blue Green | Chartreuse | Light Green | Pistachio | Cactus | Orange | Dark Green |
| | | | | | | | | | | |
| V-356 [O] (S) | V-359 [O] (S) | V-360 [O] (S) | V-361 [O] (S) | V-362 [O] (S) | V-363 [O] (S) | V-364 [O] (S) | V-365 [O] (S) | V-366 [O] (S) | V-370 [O] (S) | V-375 [O] (S) |
| Pearl Gray | Ultra White | White | Jet Black | Ultra Black | Morning Fog | Elephant | Slate | Teddy Bear Brown | Velour Black | Maroon |
| | | | | | | | | | | |
| V-376 [O] (S) | V-379 [O] (S) | V-380 [O] (S) | V-381 [O] (S) | V-382 [O] (S) | V-383 [O] (S) | V-384 [O] (S) | V-385 [O] (S) | V-386 [O] (S) | V-387 [O] (S) | V-388 [O] (S) |
| Hunter Green | Ultra Violet | Violet | Amethyst | Red | Light Red | Real Orange | Cinnamon | Electric Blue | Bright Red | Radiant Red |
| | | | | | | | | | | |
| V-389 [O] (S) | V-390 [O] (S) | V-391 [O] (S) | NEW! V-392 [O] (S) | | | | | | | |
| Flame Orange | Bright Orange | Intense Yellow | Blood Orange | | | | | | | |

UNDERGLAZES

[O]=Opaque

(S) Only glazes marked with the spray symbol may be used for safe spray application.

(F) Food safe when covered by any food safe glaze such as AMACO® LG-10 or HF-9 clear glazes. AMACO® Velvets should not be used alone on surfaces intended for food.

For more information visit
velvets.info

VELVETS FIRE TRUE TO COLOR!

Velvet Underglazes color chips shown fired at Cone 05 on AMACO® 25-M White Clay bisque buttons. One half of each button is shown with LG-10 Clear Transparent Glaze.

Tableware producers must have all finished ware tested and approved as safe for food through a certified laboratory due to possible variations in firing temperature and possible contamination.

Standard Shipping Unit is 12 (2 oz. and 16 oz.) and 4 (Gallons).

LEAD FREE VELVET UNDERGLAZES

Mix and layer hundreds of colors! Their saturated color, dependability and versatility make Velvets as popular for pros as they are for children. Velvets fire true-to-color as a Cone 05/06 underglaze or fired to Cone 6. Try two finish possibilities: When left unglazed, these colors have the rich, textural appearance of velvet; when covered with an AMACO® Clear Gloss glaze, they intensify in color. Can be applied easily to wet clay, greenware or mature Cone 04 bisque (1971° F, 1077° C).



(AP) LEAD FREE (V) UNDERGLAZES

The Art & Creative Materials Institute AP (Approved Product) seal certifies this product to be safe for use by all ages.

| Series No. | Color | 2 fl. oz. | | Pint Liquid | | Gallon Liquid | |
|------------|--------------------------|-----------|---------|-------------|---------|---------------|----------|
| | | Cat. No. | Price | Cat. No. | Price | Cat. No. | Price |
| V-301 | Ivory Beige | 37400A | \$7.70 | 37501K | \$29.70 | | |
| V-303 | Terra Cotta | 37402C | \$7.70 | 37451M | \$29.70 | | |
| V-304 | Straw | 37403D | \$7.70 | 37502L | \$29.70 | | |
| V-308 | Yellow | 37404E | \$7.70 | 37460A | \$29.70 | | |
| V-309 | Deep Yellow | 37405F | \$7.70 | 37452N | \$29.70 | | |
| V-311 | Nectar NEW! | 37632L | \$10.80 | 37594K | \$61.50 | | |
| V-313 | Red Brown | 37407H | \$7.70 | 37449K | \$29.70 | | |
| V-314 | Chocolate Brown | 37408J | \$7.70 | 37409K | \$29.70 | | |
| V-315 | Peach | 37410L | \$7.70 | 37484N | \$29.70 | | |
| V-317 | Coral | 37590E | \$7.70 | 37545B | \$29.70 | | |
| V-318 | Rose | 37413P | \$7.70 | 37461B | \$29.70 | | |
| V-320 | Lavender | 37414R | \$9.50 | 37462C | \$42.50 | | |
| V-321 | Lilac | 37415S | \$7.70 | 37454R | \$29.70 | | |
| V-322 | Purple | 37416T | \$7.70 | 37445F | \$29.70 | | |
| V-323 | Salmon | 37417W | \$7.70 | 37446G | \$29.70 | | |
| V-324 | Blush | 37591F | \$7.70 | 37546E | \$29.70 | | |
| V-325 | Baby Blue | 37418X | \$7.70 | 37463D | \$29.70 | | |
| V-326 | Medium Blue | 37419Y | \$7.70 | 37447H | \$29.70 | | |
| V-327 | Turquoise Blue | 37420A | \$7.70 | 37485P | \$29.70 | | |
| V-328 | Iceberg Blue | 37421B | \$7.70 | 37453P | \$29.70 | | |
| V-329 | Sea Glass NEW! | 37633M | \$7.70 | 37595L | \$29.70 | | |
| V-330 | Indigo NEW! | 37634J | \$7.70 | 37596M | \$29.70 | | |
| V-332 | Teal Blue | 37422C | \$7.70 | 37464E | \$29.70 | | |
| V-333 | Avocado | 37423D | \$7.70 | 37509S | \$29.70 | | |
| V-336 | Royal Blue | 37425F | \$10.80 | 37486R | \$61.50 | | |
| V-341 | Blue Green | 37426G | \$7.70 | 37448J | \$29.70 | | |
| V-343 | Chartreuse | 37427H | \$7.70 | 37675L | \$29.70 | | |
| V-345 | Light Green | 37428J | \$7.70 | 37498F | \$29.70 | | |
| V-347 | Pistachio | 37592G | \$7.70 | 37547C | \$29.70 | | |
| V-349 | Cactus | 37593H | \$7.70 | 37548F | \$29.70 | | |
| V-350 | Orange | 37429K | \$7.70 | 37503J | \$29.70 | | |
| V-353 | Dark Green | 37430L | \$7.70 | 37455S | \$29.70 | | |
| V-356 | Pearl Gray | 37433P | \$7.70 | 37412N | \$29.70 | | |
| V-359 | Ultra White | 37625D | \$9.50 | 37631K | \$42.50 | | |
| V-360 | White | 37435S | \$7.70 | 37436T | \$29.70 | 37527S | \$145.00 |
| V-361 | Jet Black | 37437W | \$7.70 | 37438X | \$29.70 | 37528T | \$145.00 |
| V-362 | Ultra Black | 37624C | \$9.50 | 37630H | \$42.50 | | |
| V-363 | Morning Fog | 37621X | \$9.50 | 37627F | \$42.50 | | |
| V-364 | Elephant | 37622A | \$10.80 | 37628J | \$61.50 | | |
| V-365 | Slate | 37623B | \$10.80 | 37629G | \$61.50 | | |
| V-366 | Teddy Bear Brown | 37439Y | \$7.70 | 37679S | \$29.70 | | |
| V-370 | Velour Black | 37443D | \$9.50 | 37456T | \$42.50 | | |
| V-375 | Maroon | 37494B | \$10.80 | 37489T | \$61.50 | | |
| V-376 | Hunter Green | 37495C | \$7.70 | 37490V | \$29.70 | | |
| V-379 | Ultra Violet | 37620S | \$10.80 | 37626E | \$61.50 | | |
| V-380 | Violet | 37475D | \$10.80 | 37466H | \$61.50 | | |
| V-381 | Amethyst | 37476E | \$10.80 | 37467G | \$61.50 | | |
| V-382 | Red | 37480J | \$10.80 | 37468J | \$61.50 | | |
| V-383 | Light Red | 37482L | \$10.80 | 37469K | \$61.50 | | |
| V-384 | Real Orange | 37483M | \$10.80 | 37470L | \$61.50 | | |
| V-385 | Cinnamon | 37499G | \$7.70 | 37497E | \$29.70 | | |
| V-386 | Electric Blue | 37500H | \$7.70 | 37674K | \$29.70 | | |
| V-387 | Bright Red | 37504M | \$10.80 | 37510V | \$61.50 | | |
| V-388 | Radiant Red | 37505N | \$10.80 | 37511W | \$61.50 | | |
| V-389 | Flame Orange | 37506P | \$10.80 | 37512X | \$61.50 | | |
| V-390 | Bright Orange | 37507R | \$10.80 | 37513A | \$61.50 | | |
| V-391 | Intense Yellow | 37508T | \$10.80 | 37514B | \$61.50 | | |
| V-392 | Blood Orange NEW! | 37635N | \$10.80 | 37597R | \$61.50 | | |



Nikki Mizak used various AMACO® Velvet Underglaze colors to glaze this cup.



UNDERGLAZES

LEAD FREE CONE 05 LIQUID (LUG) UNDERGLAZES FOR BISQUE, GREENWARE AND WET CLAY



LUG-1 [O] (F) Black

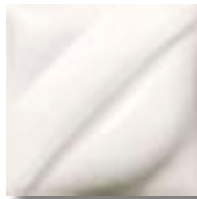

LUG-10 [O] (F) White



LUG-15 [O] (F) Warm Gray

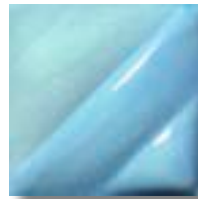

LUG-20 [O] (F) Light Blue



LUG-21 [O] (F) Medium Blue

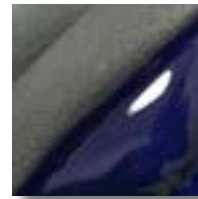

LUG-22 [O] (F) Dark Blue



LUG-25 [O] (F) Turquoise



LUG-26 [O] (F) Aqua



LUG-30 [O] (F) Light Brown



LUG-40 [O] (F) Chartreuse

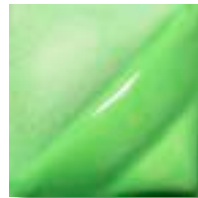

LUG-41 [O] (F) Warm Green

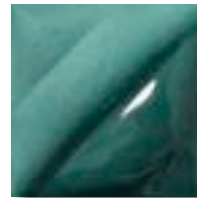

LUG-42 [O] (F) Blue Green

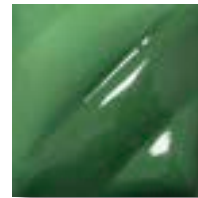

LUG-43 [O] (F) Dark Green

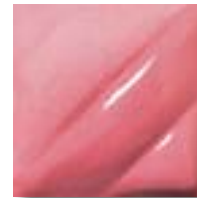

LUG-50 [O] (F) Pink

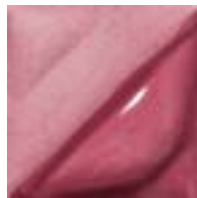

LUG-51 [O] (F) Rose

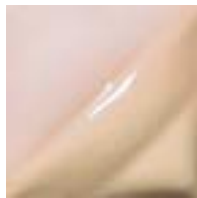

LUG-53 [O] (F) Sun Tan



LUG-54 [O] (F) Lilac

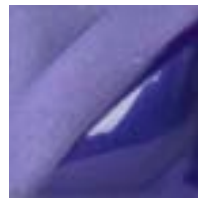

LUG-55 [O] (F) Purple

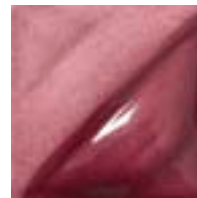

LUG-56 [O] (F) Maroon

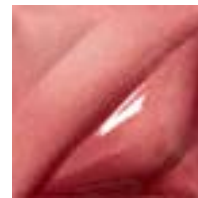

LUG-58 [O] (F) Dark Red



LUG-60 [O] (F) Light Yellow

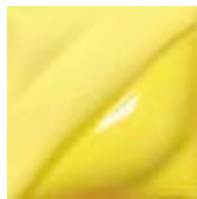

LUG-61 [O] (F) Bright Yellow



LUG-65 [O] (F) Orange

UNDERGLAZES

[O]=Opaque

(F) Only glazes marked with the spray symbol may be used for safe spray application.

(F) Food safe when covered by any food safe glaze such as AMACO® LG-10 or HF-9 clear glazes. AMACO® LUG's should not be used alone on surfaces intended for food.

LUG Series underglaze color chips shown fired at Cone 05 on AMACO® 25-M White Clay bisque buttons with one-half under LG-10 Clear Transparent Glaze.

Tableware producers must have all finished ware tested and approved as safe for food through a certified laboratory due to possible variations in firing temperature and possible contamination. Standard Shipping Unit is 12 (2 oz. and 16 oz.) and 4 (Gallons).

LEAD FREE (LUG) LIQUID UNDERGLAZES

Cone 05.

These colors will cover large areas quickly. Also great for detailed painting, sgraffito, watercolor effects, wax resists, and mishima decoration. AMACO® LUG's may be brushed on wet clay or greenware which is to be bisque fired before applying a covering glaze, or on mature Cone 04 bisque before applying a covering glaze.



Conforms to
ASTM D-4236

(AP) LEAD FREE (LUG) UNDERGLAZES

The Art & Creative Materials Institute AP (Approved Product) seal certifies this product to be safe for use by all ages.

| Series No. | Color | 2 fl. oz. | | Pint Liquid | | Gallon Liquid | |
|------------|---------------|-----------|---------|-------------|---------|---------------|----------|
| | | Cat. No. | Price | Cat. No. | Price | Cat. No. | Price |
| LUG-1 | Black | 41141N | \$10.00 | 41171H | \$34.70 | 41169G | \$195.00 |
| LUG-10 | White | 41142P | \$10.00 | 41172W | \$34.70 | 41170E | \$195.00 |
| LUG-15 | Warm Gray | 41143B | \$10.00 | 41173X | \$34.70 | | |
| LUG-20 | Light Blue | 41144R | \$10.00 | 41174Y | \$34.70 | | |
| LUG-21 | Medium Blue | 41145B | \$10.00 | 41175A | \$34.70 | | |
| LUG-22 | Dark Blue | 41146T | \$10.00 | 41176B | \$34.70 | | |
| LUG-25 | Turquoise | 41147E | \$10.00 | 41177C | \$34.70 | | |
| LUG-26 | Aqua | 41148H | \$10.00 | 41178D | \$34.70 | | |
| LUG-30 | Light Brown | 41149W | \$10.00 | 41179E | \$34.70 | | |
| LUG-40 | Chartreuse | 41151Y | \$10.00 | 41181G | \$34.70 | | |
| LUG-41 | Warm Green | 41152A | \$10.00 | 41182H | \$34.70 | | |
| LUG-42 | Blue Green | 41153B | \$10.00 | 41183J | \$34.70 | | |
| LUG-43 | Dark Green | 41154C | \$10.00 | 41184K | \$34.70 | | |
| LUG-50 | Pink | 41155D | \$10.00 | 41185L | \$34.70 | | |
| LUG-51 | Rose | 41156E | \$10.00 | 41186M | \$34.70 | | |
| LUG-53 | Sun Tan | | | 41188P | \$34.70 | | |
| LUG-54 | Lilac | 41159H | \$10.00 | 41189B | \$34.70 | | |
| LUG-55 | Purple | 41160J | \$10.00 | 41190R | \$34.70 | | |
| LUG-56 | Maroon | | | 41191S | \$34.70 | | |
| LUG-58 | Dark Red | 41122H | \$10.00 | 41123J | \$34.70 | | |
| LUG-60 | Light Yellow | | | 41192T | \$34.70 | | |
| LUG-61 | Bright Yellow | 41163M | \$10.00 | 41193E | \$34.70 | | |
| LUG-65 | Orange | 41164N | \$10.00 | 41194H | \$34.70 | | |



Rachel Rewerts used various AMACO® Liquid Underglaze colors to glaze this mini tile mural.

UNDERGLAZES

LUG TEMPERATURE/COLOR VARIATION

| | Cone 5 Glazed With HF-9 | Cone 10 Glazed With HF-9 |
|--------|-----------------------------|-----------------------------|
| LUG-1 | Black | Black |
| LUG-10 | White | White |
| LUG-15 | Gray | Gray |
| LUG-20 | Light Blue | Turquoise Blue |
| LUG-21 | Medium Blue | Medium Blue |
| LUG-22 | Dark Blue | Dark Blue |
| LUG-25 | Turquoise | Turquoise |
| LUG-26 | Dark Aqua | Green |
| LUG-30 | Light Brown (rough surface) | Light Brown (rough surface) |
| LUG-40 | Chartreuse | Pale Green |
| LUG-42 | Dark Blue Green | Dark Blue Green |
| LUG-43 | Dark Green | Dark Green |
| LUG-50 | Pink | Pink |
| LUG-51 | Irregular Washed Out Rose | Dirty White |
| LUG-53 | Sun Tan | Dark Sun Tan |
| LUG-54 | Light Lilac | Irregular Washed Out Lilac |
| LUG-55 | Washed Out Medium Blue | Washed Out Dark Blue |
| LUG-56 | Irregular Rose | Dirty Pale Rose |
| LUG-60 | Light Yellow | Greenish Yellow |
| LUG-61 | Bright Yellow | Greenish Bright Yellow |
| LUG-65 | Tan Brown | Light Tan Brown |



UNDERGLAZES

LEAD FREE CONE 05 SEMI-MOIST UNDERGLAZES FOR BISQUE, GREENWARE AND WET CLAY



Conforms to ASTM D-4236

Cone 05.

These Underglazes are intense, opaque colors which are especially good for watercolor effects and painting of fine detail. Pink, Maroon, Peach, Rose, and Yellow hold their color when fired to temperatures up to **Cone 6**. All other colors may be fired up to **Cone 10**.

The Art & Creative Materials Institute AP (Approved Product) seal certifies this product to be safe for use by all ages.



Semi-Moist Underglaze Pan Set **No. 108**

41212B.....SMUG Pan Set
No. 108, SSU=1.....\$48.50



Semi-Moist Underglaze Pan Set **No. 109**

41214S.....SMUG Pan Set
No. 109, SSU=1.....\$48.50

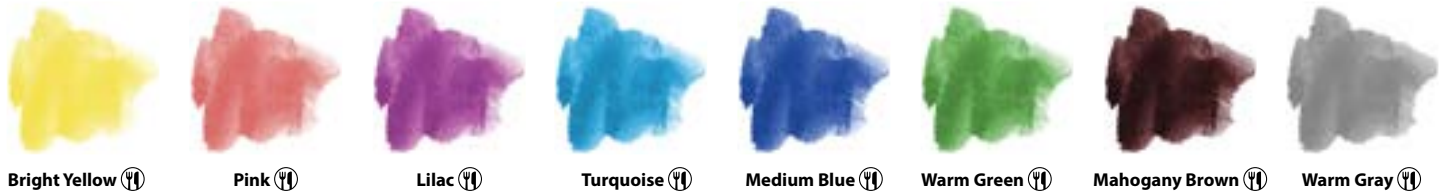

Semi-Moist Underglaze Pan Set **No. 110**

41216E.....SMUG Pan Set
No. 110, SSU=1.....\$48.50



Semi-Moist Underglaze Pan Set **No. 111**

41274K.....SMUG Pan Set
No. 111, SSU=1.....\$48.50



☞ Food safe when covered by any food safe glaze such as AMACO® LG-10 or HF-9 clear glazes. AMACO® Semi-Moist Underglazes should not be used alone on surfaces intended for food.

Tableware producers must have all finished ware tested and approved as safe for food through a certified laboratory due to possible variations in firing temperature and possible contamination.

LEAD FREE CONE 05 UNDERGLAZE CHALK CRAYONS FOR BISQUE



Conforms to ASTM D-4236

Cone 05.

The 2³/₄" x 7⁷/₁₆" Underglaze Chalk Crayons can be used like pastels on bisque pottery, which results in a pebbled appearance. Colors may be blended or smoothed by rubbing or brushing sketch with water for watercolor effects. Apply a clear glaze by dipping, pouring, or sponging then brushing.

The Art & Creative Materials Institute AP (Approved Product) seal certifies this product to be safe for use by all ages.

Underglaze Chalk Crayon Set No. 208

41252J.....Chalk Crayons
Set No. 208, SSU=1\$51.50



Underglaze Chalk Crayon Set No. 209

41253K.....Chalk Crayons
Set No. 209, SSU=1\$51.50

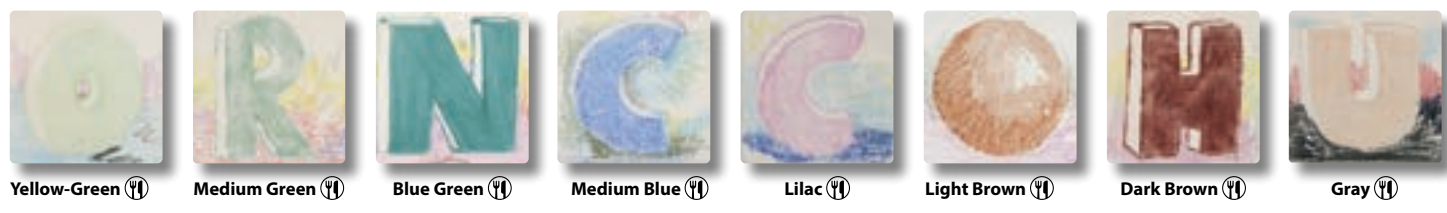

LEAD FREE CONE 05 UNDERGLAZE PENCIL FOR BISQUE



Conforms to ASTM D-4236

Cone 05.

The Underglaze Pencil is ideal for shading, fine line drawing, or identification.

The Art & Creative Materials Institute AP (Approved Product) seal certifies this product to be safe for use by all ages.

11420F.....Underglaze Pencil, Black, SSU=12\$19.50



Black (1)



Draw On Clay!

TECHNIQUE #58
VIDEO TUTORIAL
amaco.com/lesson_plans



(1) Food safe when covered by any food safe glaze such as AMACO® LG-10 or HF-9 clear glazes. AMACO® Underglaze Chalk Crayons and Underglaze Decorating Pencils should not be used alone on surfaces intended for food.

To reduce smudging with Underglaze Pencils or Chalk Crayons, mix 1 tablespoon AMACO® Gum Solution to 1 pint of water in spray bottle. Spray on work before glazing. Tableware producers must have all finished ware tested and approved as safe for food through a certified laboratory due to possible variations in firing temperature and possible contamination.



UNDERGLAZES



LEAD FREE CONE 05 "LG" GLOSS LOW FIRE GLAZES FOR BISQUE



Conforms to
ASTM D-4236



LG-1 [O] (FS) True Black

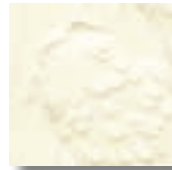

LG-10 [TP] (FS) Clear Transparent



LG-11 [O] (FS) Opaque White



LG-14 [TL] (FS) Gray

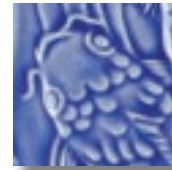

LG-20 [TP] (FS) Medium Blue

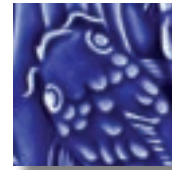

LG-21 [TP] (FS) Dark Blue



LG-23 [TP] (FS) Robin's Egg



LG-24 [TP] (FS) Light Blue



LG-25 [TP] (FS) Turquoise Green



LG-30 [TL] (FS) Chocolate Brown



LG-34 [TP] (FS) Red Brown

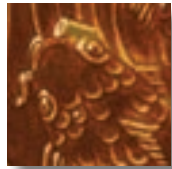

LG-36 [O] (FS) Freckled Brown

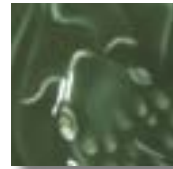

LG-40 [TP] (FS) Dark Green



LG-42 [TP] (FS) Light Green

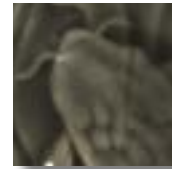

LG-44 [TP] (FS) Olive Green



LG-45 [TP] (FS) Emerald Green



LG-50 [TL] (FS) Maroon



LG-51 [TL] (FS) Lilac



LG-52 [TP] (FS) Petal Pink

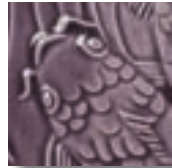

LG-54 [TP] (FS) Mulberry Red



LG-55 [TP] (FS) Purple

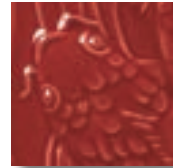

LG-57 [TL] (FS) Intense Red



LG-58 [TL] (FS) Brilliant Red



LG-59 [TL] (FS) Hot Red



LG-60 [TL] (FS) Dark Yellow



LG-61 [TL] (FS) Canary Yellow



LG-63 [TL] (FS) Brilliant Yellow



LG-65 [TP] (FS) Amber



LG-67 [TL] (FS) Fire Orange



LG-68 [TL] (FS) Vivid Orange

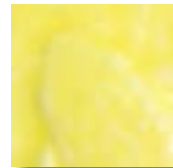

LG-760 [TL] (FS) Pale Yellow

The CL seal restricts this product from children under the age of 13. Older users must follow all cautionary labeling.



Conforms to
ASTM D-4236



LG-2 [O] (FS) Black Lustre



LG-26 [TP] (FS) Turquoise



LG-46 [TL] (FS) Leaf Green

[O]=Opaque [TP]=Transparent [TL]=Translucent

(FS) Only glazes marked with the spray symbol may be used for safe spray application.

(FS) Food Safe.

THE LG SERIES ALWAYS GIVES CONSISTENT RESULTS.

LG-10 IS OUR MOST POPULAR CLEAR GLAZE.

LG Series glaze chips are shown on AMACO® 25-M White Clay.

Tableware producers must have all finished ware tested and approved as safe for food through a certified laboratory due to possible variations in firing temperature and possible contamination.

Standard Shipping Unit is 12 (16 oz.) and 4 (Gallons).

LEAD FREE (LG) GLOSS GLAZES

Cone 05

Gloss Glazes fire to a smooth, glossy finish at a witness Cone 05 (1911°F, 1044°C). The vibrant colors provide a durable, craze resistant surface that makes this series ideal for utilitarian projects for students or production potteries. The LG series is formulated for brushing application but can be adjusted to work in pouring, dipping, and sponging applications. LG-10 is a clear, all-over covering glaze that produces a smooth, high gloss finish. Make sure it reaches a mature witness Cone 05 (1911°F, 1044°C). Apply on fully mature Cone 04 bisque. Slow fire for best results.

(AP) LEAD FREE (LG) GLAZES

The Art & Creative Materials Institute AP (Approved Product) seal certifies this product to be safe for use by all ages.



| Series No. | Color | Pint Liquid Cat. No. | Price | Gallon Liquid Cat. No. | Price |
|------------|-------------------|----------------------|---------|------------------------|----------|
| LG-1 | True Black | 39141P | \$23.00 | 39171W | \$105.00 |
| LG-10 | Clear Transparent | 39143R | \$21.00 | 39173Y | \$76.00 |
| LG-11 | Opaque White | 39144S | \$23.00 | 39174A | \$89.00 |
| LG-14 | Gray | 39145T | \$23.00 | | |
| LG-20 | Medium Blue | 38489F | \$23.00 | | |
| LG-21 | Dark Blue | 39146E | \$31.50 | | |
| LG-23 | Robin's Egg | 38490G | \$23.00 | | |
| LG-24 | Light Blue | 39147H | \$23.00 | | |
| LG-25 | Turquoise Green | 38491H | \$23.00 | | |
| LG-30 | Chocolate Brown | 38493K | \$23.00 | | |
| LG-34 | Red Brown | 38494L | \$31.50 | | |
| LG-36 | Freckled Brown | 38495M | \$31.50 | | |
| LG-40 | Dark Green | 38496N | \$23.00 | | |
| LG-42 | Light Green | 38498B | \$23.00 | | |
| LG-44 | Olive Green | 38499R | \$23.00 | | |
| LG-45 | Emerald Green | 38500S | \$23.00 | | |
| LG-50 | Maroon | 39151A | \$31.50 | | |
| LG-51 | Lilac | 38502E | \$31.50 | | |
| LG-52 | Petal Pink | 39152B | \$23.00 | | |
| LG-54 | Mulberry Red | 38503H | \$31.50 | | |
| LG-55 | Purple | 38504W | \$31.50 | | |
| LG-57 | Intense Red | 38509C | \$31.50 | | |
| LG-58 | Brilliant Red | 38510D | \$31.50 | | |
| LG-59 | Hot Red | 38511E | \$31.50 | | |
| LG-60 | Dark Yellow | 38506Y | \$23.00 | | |
| LG-61 | Canary Yellow | 39154D | \$23.00 | | |
| LG-63 | Brilliant Yellow | 38512F | \$23.00 | | |
| LG-65 | Amber | 39155E | \$31.50 | | |
| LG-67 | Fire Orange | 38513G | \$31.50 | | |
| LG-68 | Vivid Orange | 38514K | \$31.50 | | |
| LG-760 | Pale Yellow | 38508B | \$23.00 | | |

The CL seal restricts this product from children under the age of 13. Older users must follow all cautionary labeling.

| | | | |
|-------|--------------|--------|---------|
| LG-2 | Black Lustre | 39142B | \$23.00 |
| LG-26 | Turquoise | 39148W | \$23.00 |
| LG-46 | Leaf Green | 39150Y | \$23.00 |



Justin Freeman, Milford, Connecticut used AMACO® Gloss Glazes to create "Fat Boy".



GLAZES

LEAD FREE CONE 05 "TP" TEACHER'S PALETTE GLOSS LOW FIRE GLAZES FOR BISQUE



TP-1 [SO] [FS] Coal Black



TP-11 [SO] [FS] Cotton



TP-15 [SO] [FS] Gray



TP-20 [SO] [FS] Sky Blue



TP-21 [SO] [FS] Midnight Blue



TP-22 [SO] [FS] Blue Green



TP-24 [SO] [FS] Medium Blue



TP-26 [SO] [FS] Robin's Egg



TP-30 [SO] [FS] Caramel



TP-32 [SO] [FS] Fudge Brown



TP-40 [SO] [FS] Mint Green



TP-41 [SO] [FS] Frog Green



TP-42 [SO] [FS] Granny Smith



TP-43 [SO] [FS] Green Leaf



TP-51 [SO] [FS] Grape



TP-52 [SO] [FS] Raspberry



TP-53 [SO] [FS] Pig Pink



TP-54 [SO] [FS] Lilac



TP-56 [SO] [FS] Scarlet



TP-58 [SO] [FS] Brick Red



TP-60 [SO] [FS] Lemon



TP-62 [SO] [FS] Maize



TP-64 [SO] [FS] Carrot



TP-65 [SO] [FS] Pumpkin

GLAZES

[SO]=Semi-Opaque

[S] Only glazes marked with the spray symbol may be used for safe spray application.

[FS] Food Safe.

TP color chips shown fired at Cone 05 on AMACO® 25-M White Art Clay.

Tableware producers must have all finished ware tested and approved as safe for food through a certified laboratory due to possible variations in firing temperature and possible contamination. Standard Shipping Unit is 12 (16 oz.) and 4 (Gallons).

TEACHER'S PALETTE®

Painterly details with mixable colors

LEAD FREE (TP) TEACHER'S PALETTE GLOSS GLAZES

Cone 05

Food safe Teacher's Palette gloss glazes are completely intermixable so they can be blended with each other or with any of the AMACO® Teacher's Light (TPL) glazes to create an infinite color palette. They can also be layered by brushing or slip trailing on top of each other without bleeding, distortion or glaze interaction that could lead to unintended results. TP and TPL glazes fire true to the color in the bottle so you know what the fired color will look like as soon as you remove the cap. Recommended firing temperature for these glazes is Cone 05 (1911°F, 1044°C). They must be applied on a mature Cone 04 (1971°F, 1077°C) bisque.

(AP) LEAD FREE (TP) GLAZES

The Art & Creative Materials Institute AP (Approved Product) seal certifies this product to be safe for use by all ages.



Conforms to
ASTM D-4236

| Series No. | Color | Pint Liquid Cat. No. | Price |
|------------|---------------|-------------------------|---------|
| TP-1 | Coal Black | 36601A | \$20.00 |
| TP-11 | Cotton | 36602B | \$20.00 |
| TP-15 | Gray | 36603C | \$20.00 |
| TP-20 | Sky Blue | 36604D | \$20.00 |
| TP-21 | Midnight Blue | 36605E | \$20.00 |
| TP-22 | Blue Green | 36606F | \$20.00 |
| TP-24 | Medium Blue | 36633L | \$20.00 |
| TP-26 | Robin's Egg | 36635N | \$20.00 |
| TP-30 | Caramel | 36607G | \$20.00 |
| TP-32 | Fudge Brown | 36608L | \$20.00 |
| TP-40 | Mint Green | 36609H | \$20.00 |
| TP-41 | Frog Green | 36610K | \$20.00 |
| TP-42 | Granny Smith | 36637S | \$20.00 |
| TP-43 | Green Leaf | 36639V | \$20.00 |
| TP-51 | Grape | 36611M | \$20.00 |
| TP-52 | Raspberry | 36612N | \$20.00 |
| TP-53 | Pig Pink | 36613P | \$20.00 |
| TP-54 | Lilac | 36641X | \$20.00 |
| TP-56 | Scarlet | 36643A | \$20.00 |
| TP-58 | Brick Red | 36614J | \$20.00 |
| TP-60 | Lemon | 36615R | \$20.00 |
| TP-62 | Maize | 36645C | \$20.00 |
| TP-64 | Carrot | 36616T | \$20.00 |
| TP-65 | Pumpkin | 36647E | \$20.00 |

For more information on
Teacher's Palette® glazes
go to teachers-palette.info



Cara Moczygemba, Indianapolis, Indiana, used AMACO® Gloss Glazes and Teacher's Palette glazes to create "Brent Cat".



GLAZES



LEAD FREE CONE 05 "TPL" TEACHER'S PALETTE LIGHT GLAZES FOR BISQUE



Conforms to ASTM D-4236



TPL-3 [TP] (FS)
Onyx



TPL-5 [TP] (FS)
Quartz

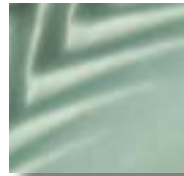

TPL-23 [TP] (FS)
Aquamarine

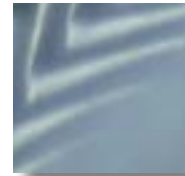

TPL-27 [TP] (FS)
Zircon

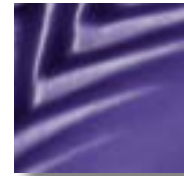

TPL-28 [TP] (FS)
Sapphire

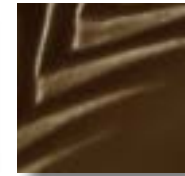

TPL-34 [TP] (FS)
Jasper



TPL-44 [TP] (FS)
Peridot

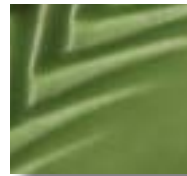

TPL-45 [TP] (FS)
Emerald



TPL-55 [TP] (FS)
Tanzanite

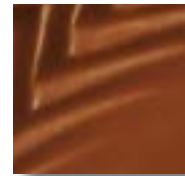

TPL-59 [TP] (FS)
Ruby

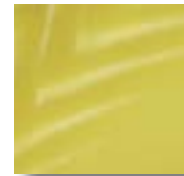

TPL-63 [TP] (FS)
Citrine

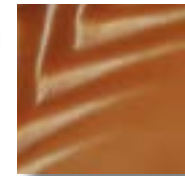

TPL-66 [TP] (FS)
Fire Opal

LEAD FREE CONE 05 "O" OPALESCENT LOW FIRE GLAZES FOR BISQUE



Conforms to ASTM D-4236



O-10 [SO] (FS)
Transparent Pearl



O-11 [SO] (FS)
White Clover



O-12 [SO] (FS)
Tawny



O-30 [SO] (FS)
Autumn Leaf



O-42 [SO] (FS)
Moss Green



O-52 [SO] (FS)
Fuchsia



O-54 [SO] (FS)
Dusty Rose



O-57 [SO] (FS)
Mottled Burgundy

The CL seal restricts this product from children under the age of 13. Older users must follow all cautionary labeling.



Conforms to ASTM D-4236

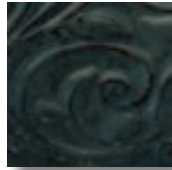

O-2 [SO] (FS)
Black Tulip



O-20 [SO] (FS)
Bluebell



O-21 [SO] (FS)
Aquamarine



O-23 [SO] (FS)
Sapphire Blue

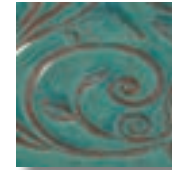

O-26 [SO] (FS)
Turquoise

For information on Opalescent glazes go to OpalescentGlazes.info

[TP]=Transparent [SO]=Semi-Opaque

(S) Only glazes marked with the spray symbol may be used for safe spray application.

(FS) Food Safe.

TPL color chips shown fired at Cone 05 on AMACO® 25-M White Art Clay.

O color chips shown fired at Cone 05 on AMACO® 67-M Sedona Red Clay. More opalescence shows on red clay.

Tableware producers must have all finished ware tested and approved as safe for food through a certified laboratory due to possible variations in firing temperature and possible contamination.

Standard Shipping Unit is 12 (16 oz.) and 4 (Gallons).

LEAD FREE (TPL) TEACHER'S PALETTE LIGHT GLAZES

Cone 05.

Teacher's Palette Light (TPL) translucent gloss glazes may be blended with each other or any Teacher's Palette (TP) glaze. Layer by brushing or slip trailing without bleeding of colors. Enhances texture and works over underglaze decoration. Apply over Cone 04 (1971°F, 1077°C) fired bisque.

(AP) LEAD FREE (TPL) GLAZES

The Art & Creative Materials Institute AP (Approved Product) seal certifies this product to be safe for use by all ages.



| Series No. | Color | Pint Liquid Cat. No. | Price |
|------------|------------|----------------------|---------|
| TPL-3 | Onyx | 37707G | \$20.00 |
| TPL-5 | Quartz | 37701A | \$20.00 |
| TPL-23 | Aquamarine | 37704D | \$20.00 |
| TPL-27 | Zircon | 37705E | \$20.00 |
| TPL-28 | Sapphire | 37706F | \$20.00 |
| TPL-34 | Jasper | 37708L | \$20.00 |
| TPL-44 | Peridot | 37703C | \$20.00 |
| TPL-45 | Emerald | 37702B | \$20.00 |
| TPL-55 | Tanzanite | 37712K | \$20.00 |
| TPL-59 | Ruby | 37711P | \$20.00 |
| TPL-63 | Citrine | 37709H | \$20.00 |
| TPL-66 | Fire Opal | 37710J | \$20.00 |



AMACO® Teacher's Palette Light glazes were used to decorate this green face vase.

LEAD FREE (O) OPALESCENT GLAZES

Cone 05

Food safe Opalescent Glazes develop their greatest opalescence and most interesting textures when applied over red clay. On textured ware, the glaze flows thin on relief and thick in incised areas, illuminating dimension. AMACO® Opalescent Glazes are supplied in liquid, ready-to-use form. They are applied on a mature Cone 04 (1971°F, 1077°C) bisque by brushing, dipping, or pouring. On red bisque, these glazes should be applied more heavily than other colors of clay. Recommended firing temperature is Cone 05 (1911°F, 1044°C).

(AP) LEAD FREE (O) GLAZES

The Art & Creative Materials Institute AP (Approved Product) seal certifies this product to be safe for use by all ages.



| Series No. | Color | Pint Liquid Cat. No. | Price |
|------------|-------------------|----------------------|---------|
| O-10 | Transparent Pearl | 38660S | \$23.00 |
| O-11 | White Clover | 38631K | \$23.00 |
| O-12 | Tawny | 38661T | \$23.00 |
| O-30 | Autumn Leaf | 38664Y | \$23.00 |
| O-42 | Moss Green | 38635P | \$23.00 |
| O-52 | Fuchsia | 38636B | \$23.00 |
| O-54 | Dusty Rose | 38667C | \$23.00 |
| O-57 | Mottled Burgundy | 38637R | \$23.00 |

The CL seal restricts this product from children under the age of 13. Older users must follow all cautionary labeling.



| | | | |
|------|---------------|--------|---------|
| O-2 | Black Tulip | 38630J | \$23.00 |
| O-20 | Bluebell | 38632L | \$23.00 |
| O-21 | Aquamarine | 38663X | \$23.00 |
| O-23 | Sapphire Blue | 38633M | \$23.00 |
| O-26 | Turquoise | 38634N | \$23.00 |



AMACO® Opalescent glazes were used to decorate this serving dish.



GLAZES

ceramicglazes-underglazes.com

LEAD FREE CONE 05 "LM" MATT LOW FIRE GLAZES FOR BISQUE



Conforms to
ASTM D-4236

Cone 05

Dinnerware safe Matt Glazes provide a smooth, satin finish for pottery and tile. LM-10 Transparent Matt is formulated for use over all AMACO® underglazes. It allows underglaze decoration to fire vibrant and crisp with no "cloudy" look. Recommended firing temperature for these glazes is Cone 05 (1911°F, 1044°C). They must be applied on a mature Cone 04 (1971°F, 1077°C) bisque.

The Art & Creative Materials Institute AP (Approved Product) seal certifies this product to be safe for use by all ages.

| Series No. | Color | Pint Liquid Cat. No. | Price | Gallon Liquid Cat. No. | Price |
|------------|------------------|----------------------|---------|------------------------|---------|
| LM-10 | Transparent Matt | 39232N | \$23.00 | 39244B | \$89.00 |
| LM-11 | Opaque White | 39233P | \$23.00 | | |



LM-10 [TL]
Transparent Matt



LM-11 [O]
Opaque White



Cups created by Justin Rothshank are glazed with AMACO® LM-11 Opaque White and LM-10 Transparent Matt.

[O]=Opaque [TP]=Transparent [TL]=Translucent

Only glazes marked with the spray symbol may be used for safe spray application.

Food Safe.

LEAD FREE CONE 05 "DC" DIPPING CLEAR LOW FIRE GLAZES FOR BISQUE



Conforms to
ASTM D-4236

Cone 05.

DC-10 Clear Glaze is formulated for dipping. Dip the Cone 04 (1971°F, 1077°C) bisque fired piece into the glaze, lift it out and turn it over, allowing the excess glaze to pour out. Fire to mature Cone 05 (1911°F, 1044°C).

The Art & Creative Materials Institute AP (Approved Product) seal certifies this product to be safe for use by all ages.

| Cat. No. | Color | Price |
|----------|-----------------------------------|------------------|
| 39303D | DC-10 Clear Glaze, liquid, gallon | \$63.00 SSU=4 |

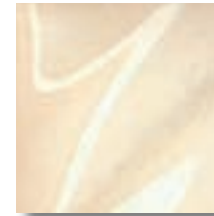

DC-10
Clear Glaze

Tableware producers must have all finished ware tested and approved as safe for food through a certified laboratory due to possible variations in firing temperature and possible contamination. Standard Shipping Unit is 12 (16 oz.) and 4 (Gallons).

LEAD FREE CONE 05 "TL-1" TEXTURIZER LOW FIRE GLAZE FOR BISQUE

Conforms to
ASTM D-4236

Cone 05.

Apply TL-1 Texturizer over any Cone 05 unfired glaze or between coats of two different glazes to create different textures.

This product does not carry any seal but include the wording "Conforms to ASTM D-4236".

| Cat. No. | Color | Price |
|----------|-----------------------------------|---------|
| 37030L | TL-1 Texturizer, one pint, liquid | \$19.00 |

WARNING: This product can expose you to chemicals including Lithium carbonate, which are known to the State of California to cause birth defects or other reproductive harm. For more information go to www.P65Warnings.ca.gov.



TL-1
Over LG-24
Light Blue



Top of pot shown with
AMACO® TL-1 Texturizer.

CHOOSE YOUR GLAZE for the effect you want

LOW FIRE Cone 05



TEACHER'S PALETTE (TP) for painterly details

semi-opaque gloss colors that "stay put"
for controlled brushwork



TEACHER'S PALETTE LIGHT (TPL) for enhancing texture

translucent mixable colors
that highlight texture



LG SERIES (LOWFIRE GLOSS) for enhancing texture

38 brilliant semi-transparent colors that
break and pool to highlight texture



OPALESCENT (O) for pearl like surfaces

opalescence shows more on red clay
glaze breaks and pools to highlight texture



GLAZES

LEAD FREE CONE 5-6 "C" CELADON MID/HIGH FIRE GLAZES FOR PORCELAIN & STONEWARE



Conforms to
ASTM D-4236



C-1 [TP] (F) Obsidian



C-3 [TP] (F) Smoke



C-5 [TP] (F) Charcoal



C-10 [TP] (F) Snow



C-11 [TP] (F) Mixing Clear

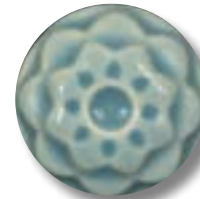

C-19 [TP] (F) Glacier

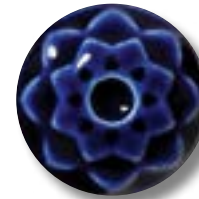

C-20 [TP] (F) Cobalt



C-21 [TP] (F) Sky



C-22 [TP] (F) Fog



C-23 [TP] (F) Ice



NEW!
C-24 [TP] (F) Succulent

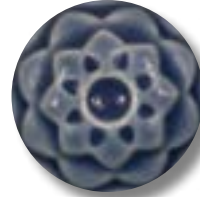

C-25 [TP] (F) Downpour



NEW!
C-26 [TP] (F) Lagoon

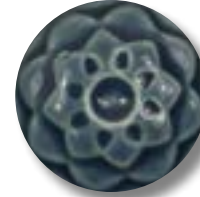

C-29 [TP] (F) Deep Sea

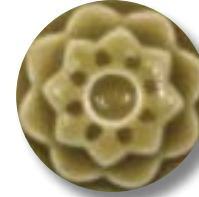

C-32 [TP] (F) Ochre



NEW!
C-33 [TP] (F) Sandalwood



C-36 [TP] (F) Iron

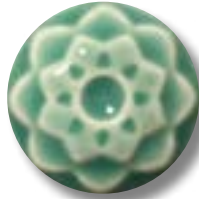

C-40 [TP] (F) Aqua



C-41 [TP] (F) Pear



NEW!
C-42 [TP] (F) Saguaro



C-43 [TP] (F) Wasabi

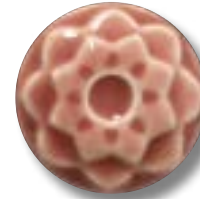

C-50 [TP] (F) Cherry Blossom



NEW!
C-52 [TP] (F) Red Rock



C-53 [TP] (F) Weeping Plum



C-54 [TP] (F) Snapdragon



C-55 [TP] (F) Poppy



C-56 [TP] (F) Lavender



C-57 [TP] (F) Mulberry



C-60 [TP] (F) Marigold

The CL seal restricts this product from children under the age of 13. Older users must follow all cautionary labeling.



Conforms to
ASTM D-4236



C-27 [TP] (F) Storm



C-47 [TP] (F) Jade



C-49 [TP] (F) Rainforest

Please see next page for the seals and warnings
all colors carry in the dry dipping form.

Celadons are transparent gloss glazes that flow and pool in texture.

Tableware producers must have all finished ware tested and approved as safe for food through a certified laboratory due to possible variations in firing temperature and possible contamination.

Standard Shipping Unit for liquid brushing glaze is 12 (16 oz.) and 4 (Gallons).
Standard Shipping Unit for dry dipping glaze is 1.

[TP]=Transparent

(S) Only glazes marked with the spray symbol may be used for safe spray application.

(F) Food Safe.

LEAD FREE (C) CELADON GLAZES

Cone 5-6.

Cone 5/6 transparent gloss glazes that are formulated to be 100% mixable. Now, you can blend your own celadon color and transparency. Food Safe and Lead Free.

(AP) LEAD FREE (C) GLAZES

The Art & Creative Materials Institute AP (Approved Product) seal certifies this product to be safe for use by all ages.



| Series No. | Color | Pint Liquid | | Gallon Liquid | |
|------------|------------------------|-------------|---------|---------------|---------|
| | | Cat. No. | Price | Cat. No. | Price |
| C-1 | Obsidian | 39401A | \$20.00 | 39419W | \$94.00 |
| C-3 | Smoke | 39425E | \$20.00 | | |
| C-5 | Charcoal | 39426F | \$20.00 | | |
| C-10 | Snow | 39402B | \$20.00 | 39420X | \$94.00 |
| C-11 | Mixing Clear | 39403C | \$20.00 | 39421A | \$94.00 |
| C-19 | Glacier | 39427G | \$20.00 | | |
| C-20 | Cobalt | 39404D | \$20.00 | 39422B | \$94.00 |
| C-21 | Sky | 39405E | \$20.00 | 39423C | \$94.00 |
| C-22 | Fog | 39406F | \$20.00 | | |
| C-23 | Ice | 39407G | \$20.00 | | |
| C-24 | Succulent NEW! | 39435R | \$20.00 | | |
| C-25 | Downpour | 39428L | \$20.00 | | |
| C-26 | Lagoon NEW! | 39436T | \$20.00 | | |
| C-29 | Deep Sea | 39429H | \$20.00 | | |
| C-32 | Ochre | 39430J | \$20.00 | | |
| C-33 | Sandalwood NEW! | 39438V | \$20.00 | | |
| C-36 | Iron | 39409H | \$20.00 | | |
| C-40 | Aqua | 39410K | \$20.00 | | |
| C-41 | Pear | 39411P | \$20.00 | | |
| C-42 | Saguaro NEW! | 39437S | \$20.00 | | |
| C-43 | Wasabi | 39412M | \$20.00 | | |
| C-50 | Cherry Blossom | 39415R | \$20.00 | | |
| C-52 | Red Rock NEW! | 39439X | \$20.00 | | |
| C-53 | Weeping Plum | 39416T | \$20.00 | | |
| C-54 | Snapdragon | 39433P | \$20.00 | | |
| C-55 | Poppy | 39431K | \$20.00 | | |
| C-56 | Lavender | 39417S | \$20.00 | | |
| C-57 | Mulberry | 39434N | \$20.00 | | |
| C-60 | Marigold | 39418V | \$20.00 | | |
| C-65 | Tangelo | 39432M | \$20.00 | | |

The CL seal restricts this product from children under the age of 13. Older users must follow all cautionary labeling.

| | | | | | |
|------|------------|--------|---------|--------|---------|
| C-27 | Storm | 39408L | \$20.00 | 39424D | \$94.00 |
| C-47 | Jade | 39413N | \$20.00 | | |
| C-49 | Rainforest | 39414J | \$20.00 | | |



Cara Moczygema, Indianapolis, Indiana, created this yarn bowl and glazed it with C-49 Rainforest.

These colors do not carry any seal but include the wording "Conforms to ASTM D-4236".

| Series No. | Color | 10-lb. Dry Dipping Glazes | |
|------------|----------------|---------------------------|----------|
| | | Cat. No. | Price |
| C-1 | Obsidian | 39501A | \$112.00 |
| C-3 | Smoke | 39556T | \$112.00 |
| C-5 | Charcoal | 39555R | \$112.00 |
| C-10 | Snow | 39502B | \$112.00 |
| C-11 | Mixing Clear | 39503C | \$112.00 |
| C-19 | Glacier | 39557S | \$112.00 |
| C-20 | Cobalt | 39504D | \$112.00 |
| C-21 | Sky | 39505E | \$112.00 |
| C-22 | Fog | 39506F | \$112.00 |
| C-23 | Ice | 39507G | \$112.00 |
| C-25 | Downpour | 39558V | \$112.00 |
| C-29 | Deep Sea | 39559W | \$112.00 |
| C-32 | Ochre | 39560X | \$112.00 |
| C-36 | Iron | 39509K | \$112.00 |
| C-40 | Aqua | 39510M | \$112.00 |
| C-41 | Pear | 39511P | \$112.00 |
| C-43 | Wasabi | 39512H | \$112.00 |
| C-50 | Cherry Blossom | 39515R | \$112.00 |
| C-53 | Weeping Plum | 39516T | \$112.00 |
| C-54 | Snapdragon | 39563D | \$112.00 |
| C-55 | Poppy | 39561B | \$112.00 |
| C-56 | Lavender | 39517S | \$112.00 |
| C-57 | Mulberry | 39564E | \$112.00 |
| C-60 | Marigold | 39518V | \$112.00 |
| C-65 | Tangelo | 39501A | \$112.00 |

The CL seal restricts this product from children under the age of 13. Older users must follow all cautionary labeling.

| | | | |
|------|------------|--------|----------|
| C-27 | Storm | 39508L | \$112.00 |
| C-47 | Jade | 39513J | \$112.00 |
| C-49 | Rainforest | 39514N | \$112.00 |

WARNING: All colors in dry form can expose you to chemicals including Silica, crystalline (airborne particles of respirable size), which are known to the State of California to cause cancer. For more information go to www.P65Warnings.ca.gov.



GLAZES



NEW!

LEAD FREE CONE 5-6 "DL" DIPPING & LAYERING HIGH FIRE GLAZES FOR PORCELAIN & STONEWARE

The CL seal restricts this product from children under the age of 13. Older users must follow all cautionary labeling.



Conforms to ASTM D-4236



DL-1 [O] (FS) Ebony



DL-11 [O] (FS) Enamel White

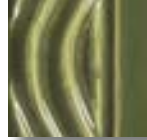

DL-42 [O] (FS) River Moss



DL-70 [O] (FS) Oxblood

These colors do not carry any seal but include the wording "Conforms to ASTM D-4236".

Conforms to ASTM D-4236



DL-20 [O] (FS) Floating Blue



DL-23 [O] (FS) Ultramarine



DL-33 [O] (FS) Low Tide



DL-60 [O] (FS) Honeycomb

LEAD FREE (DL) DIPPING & LAYERING DRY GLAZES **NEW!**

Cone 5-6.

A collection of favorite colors in an economical dry form for the production potter who wants to achieve the stunning effects of layering glazes like our brushing glazes.

Easy to mix! Follow the directions on the product to mix into 1 gallon of water, then begin dipping and layering for the effects you want. The finishes are stunning and authentic. Makes approximately 1.5 gallons of dipping glaze.

LEAD FREE (DL) DRY GLAZES

The CL seal restricts this product from children under the age of 13. Older users must follow all cautionary labeling.



Conforms to ASTM D-4236

| | | |
|------------------------------|--------------|----------|
| DL-1.....Ebony | 39801A | \$165.00 |
| DL-11.....Enamel White | 39802B | \$120.00 |
| DL-42.....River Moss..... | 39807H | \$140.00 |
| DL-70.....Oxblood..... | 39811P | \$165.00 |

These colors do not carry any seal but include the wording "Conforms to ASTM D-4236".

| | | |
|------------------------------|--------------|----------|
| DL-20.....Floating Blue..... | 39803C | \$140.00 |
| DL-23.....Ultramarine | 39804D | \$165.00 |
| DL-33.....Low Tide..... | 39806F | \$140.00 |
| DL-60.....Honeycomb | 39809G | \$165.00 |

WARNING: This product can expose you to chemicals including Silica, crystalline (airborne particles of respirable size) and titanium dioxide (airborne, unbound particles of respirable size), which are known to the State of California to cause cancer. For more information go to www.P65Warnings.ca.gov.



Plate and bowl set glazed with DL-42 River Moss.

[O]=Opaque
(FS) Food Safe.

Tableware producers must have all finished ware tested and approved as safe for food through a certified laboratory due to possible variations in firing temperature and possible contamination.
Standard Shipping Unit is 1 for dry dipping glaze.

CHOOSE YOUR GLAZE

for the effect you want

MID/HIGH FIRE

Cone 5/6



CELADON (C)

for a mixable transparent color

transparent gloss colors that “stay put” and can be mixed to increase your palette



COSMOS (CO)

glazes that are out of this world

iridescent colors with crystalline effects right out of the jar, without a hold or slow cool firing schedule



DIPPING & LAYERING (DL)

dip and layer with ease

premeasured for mixing, these colors are easy to apply and save you time glazing

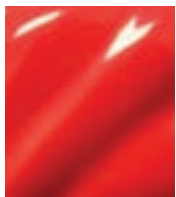

HF SERIES (HIGH FIRE)

for opaque vivid color

opaque gloss colors made for stoneware that are as colorful as earthenware glazes



POTTER'S CHOICE (PC)

for reduction looks

potter's favorite reduction surfaces in oxidation firings that can be layered to increase your palette



POTTER'S CHOICE FLUX (PCF)

for glazes that break over texture

glazes that move and are great for layering within their series or with our C's, PC's, and SH's



SATIN MATTE (SM)

for a mixable satin feel

opaque satin colors that break slightly over edges and can be mixed to increase your palette



SHINO (SH)

for a mottled, sophisticated look

warm rust base with opaque matte or gloss colors that can be mixed for color or finish



LEAD FREE CONE 5-6 "PC" POTTER'S CHOICE HIGH FIRE GLAZES FOR PORCELAIN & STONEWARE



GLAZES



Conforms to ASTM D-4236



PC-10 [O] June Bug



PC-11 [O] Blue Spark

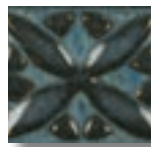

PC-12 [O] Blue Midnight



PC-16 [O] Purple Crystal



PC-17 [TP] Honey Flux



PC-20 [O] Blue Rutile



PC-21 [O] Arctic Blue



PC-22 [O] Blue Stone



PC-23 [O] Indigo Float



PC-24 [O] Sapphire Float



PC-27 [O] Tourmaline



PC-28 [O] Frosted Turquoise



PC-29 [TP] Deep Olive Speckle



PC-30 [O] Temmoku



PC-31 [TP] Oatmeal



PC-33 [O] Iron Lustre



PC-34 [O] Light Sepia



PC-36 [O] Ironstone



PC-38 [TL] Iron Yellow



PC-43 [O] Toasted Sage



PC-44 [O] Sage



PC-52 [TP] Deep Sienna Speckle



PC-53 [O] Ancient Jasper



PC-55 [O] Chun Plum



PC-57 [TL] Smokey Merlot

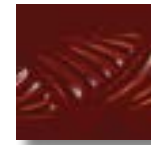

PC-59 [TP] Deep Firebrick



PC-61 [O] Textured Amber



PC-62 [TP] Textured Amber Brown



PC-63 [O] Cosmic Tea Dust



PC-64 [TL] Aventurine



PC-67 [O] River Rock

The CL seal restricts this product from children under the age of 13. Older users must follow all cautionary labeling.



Conforms to ASTM D-4236



* PC-1 [O] Saturation Metallic



PC-2 [O] Saturation Gold



PC-4 [O] Palladium



PC-9 [O] Vintage Gold



PC-15 [O] Satin Oribe



PC-25 [O] Textured Turquoise



PC-26 [O] Blue Lagoon



PC-40 [TP] True Celadon



PC-41 [O] Vert Lustre

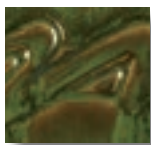

PC-42 [O] Seaweed



PC-45 [TP] Dark Green



PC-46 [O] Lustrous Jade



PC-47 [O] Emerald Falls



PC-48 [O] Art Deco Green

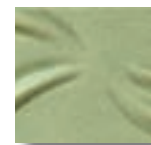

PC-49 [O] Frosted Melon



PC-66 [TP] Cosmic Oil Spot



* PC-70 [O] Copper Red



* PC-71 [O] Flambe

These colors do not carry any seal but include the wording "Conforms to ASTM D-4236".

Conforms to ASTM D-4236



* PC-32 [O] Albany Slip Brown



* PC-65 [TP] Black Aventurine

* **WARNING:** Liquid colors with an asterisk can expose you to chemicals including Lithium carbonate, which are known to the State of California to cause birth defects or other reproductive harm. For more information go to www.P65Warnings.ca.gov.

[O]=Opaque [TP]=Transparent [TL]=Translucent

☞ Only glazes marked with the spray symbol may be used for safe spray application.

🍴 Food Safe.

🚫 Not Food Safe.

LEAD FREE (PC) POTTER'S CHOICE GLAZES

Cone 5-6.

A collection of favorite potter's colors formulated to achieve Cone 10 reduction surfaces from Cone 5-6 oxidation firings! The finishes are stunning and authentic. Potters and older students choose Blue Rutile most often (which needs four coats).



Cara Moczygomba, Indianapolis, Indiana, sculpted this horse and used PC-2 Saturation Gold to decorate it.

LIQUID BRUSHING LEAD FREE (PC) GLAZES

The Art & Creative Materials Institute AP (Approved Product) seal certifies this product to be safe for use by all ages.

| Series No. | | Color | Pint Liquid Brushing Glazes | | Gallon Liquid Brushing Glazes | |
|------------|-------|----------------------|-----------------------------|---------|-------------------------------|----------|
| | | | Cat. No. | Price | Cat. No. | Price |
| PC-10 | | June Bug | 35523F | \$36.00 | | |
| PC-11 | | Blue Spark | 35525H | \$36.00 | | |
| PC-12 | | Blue Midnight | 35429N | \$21.00 | 35442F | \$94.00 |
| PC-16 | | Purple Crystal | 35533V | \$21.00 | | |
| PC-17 | | Honey Flux | 35534S | \$21.00 | 35604D | \$94.00 |
| PC-20 | | Blue Rutile | 35401D | \$21.00 | 35407K | \$94.00 |
| PC-21 | | Arctic Blue | 35462F | \$21.00 | 35463G | \$94.00 |
| PC-22 | | Blue Stone | 35499B | \$21.00 | 35500A | \$94.00 |
| PC-23 | | Indigo Float | 35430R | \$21.00 | 35443H | \$94.00 |
| PC-24 | | Sapphire Float | 35477X | \$23.25 | 35485H | \$94.00 |
| PC-27 | | Tourmaline | 35431P | \$21.00 | 35444J | \$94.00 |
| PC-28 | | Frosted Turquoise | 35432S | \$23.25 | | |
| PC-29 | | Deep Olive Speckle | 35433T | \$23.25 | 35446M | \$94.00 |
| PC-30 | | Temmoku | 35402E | \$21.00 | 35408L | \$94.00 |
| PC-31 | | Oatmeal | 35470N | \$21.00 | 35471P | \$94.00 |
| PC-33 | | Iron Lustre | 35434V | \$21.00 | 35447G | \$94.00 |
| PC-34 | | Light Sepia | 35435W | \$21.00 | 35448N | \$94.00 |
| PC-36 | | Ironstone | 35421D | \$21.00 | 35425H | \$94.00 |
| PC-38 | | Iron Yellow | 35479B | \$21.00 | 35487J | \$94.00 |
| PC-43 | | Toasted Sage | 35438C | \$21.00 | 35451S | \$94.00 |
| PC-44 | | Sage | 35476W | \$21.00 | | |
| PC-52 | | Deep Sienna Speckle | 35440E | \$23.25 | 35453T | \$94.00 |
| PC-53 | | Ancient Jasper | 35460E | \$21.00 | 35461D | \$94.00 |
| PC-55 | | Chun Plum | 35424G | \$23.25 | 35428L | \$114.00 |
| PC-57 | | Smokey Merlot | 35466J | \$23.25 | 35467K | \$114.00 |
| PC-59 | | Deep Firebrick | 35441D | \$23.25 | 35454W | \$94.00 |
| PC-61 | | Textured Amber | 35472R | \$21.00 | | |
| PC-62 | | Textured Amber Brown | 35474T | \$21.00 | | |
| PC-63 | | Cosmic Tea Dust | 35483F | \$21.00 | 35491P | \$94.00 |
| PC-64 | | Aventurine | 35484G | \$21.00 | | |
| PC-67 | | River Rock | 35497X | \$21.00 | 35498C | \$94.00 |



GLAZES



The CL seal restricts this product from children under the age of 13.

Older users must follow all cautionary labeling.

| | | | | | | |
|--------|-------|----------------------|--------|---------|--------|----------|
| PC-1* | | Saturation Metallic* | 35413T | \$36.00 | 35416W | \$138.00 |
| PC-2 | | Saturation Gold | 35419A | \$21.00 | 35417X | \$94.00 |
| PC-4 | | Palladium | 35456A | \$23.25 | 35457B | \$94.00 |
| PC-9 | | Vintage Gold | 35524G | \$23.25 | 35530R | \$114.00 |
| PC-15 | | Satin Orbe | 35521D | \$21.00 | 35522E | \$94.00 |
| PC-25 | | Textured Turquoise | 35420B | \$21.00 | 35418C | \$94.00 |
| PC-26 | | Blue Lagoon | 35493S | \$21.00 | 35494T | \$94.00 |
| PC-40 | | True Celadon | 35404G | \$21.00 | 35410N | \$94.00 |
| PC-41 | | Vert Lustre | 35458L | \$21.00 | 35459C | \$94.00 |
| PC-42 | | Seaweed | 35422E | \$21.00 | 35426K | \$94.00 |
| PC-45 | | Dark Green | 35468L | \$21.00 | 35469M | \$94.00 |
| PC-46 | | Lustrous Jade | 35423F | \$21.00 | 35427M | \$94.00 |
| PC-47 | | Emerald Falls | 35495V | \$21.00 | 35496W | \$94.00 |
| PC-48 | | Art Deco Green | 35464J | \$23.25 | 35465H | \$114.00 |
| PC-49 | | Frosted Melon | 35439B | \$21.00 | | |
| PC-66 | | Cosmic Oil Spot | 35537A | \$23.25 | | |
| PC-70* | | Copper Red* | 35527L | \$23.25 | 35528M | \$114.00 |
| PC-71* | | Flambe* | 35526K | \$23.25 | 35529N | \$114.00 |

These colors do not carry any seal but include the wording "Conforms to ASTM D-4236".

| | | | | | | |
|--------|-------|--------------------|--------|---------|--------|----------|
| PC-32* | | Albany Slip Brown* | 35414S | \$23.25 | 35415V | \$114.00 |
| PC-65* | | Black Aventurine* | 35536X | \$23.25 | | |

*⚠️ **WARNING:** Liquid colors with an asterisk can expose you to chemicals including Lithium carbonate, which are known to the State of California to cause birth defects or other reproductive harm. For more information go to www.P65Warnings.ca.gov.



NEW!

LEAD FREE CONE 5-6 "PCF" HIGH FIRE POTTER'S CHOICE FLUX GLAZES FOR PORCELAIN & STONWARE

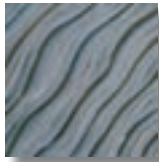

PCF-3 [O] (Midnight Run)



PCF-19 [TL] (Cirrus Flow)

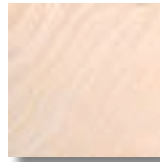

PCF-54 [TL] (Flux Blossom)

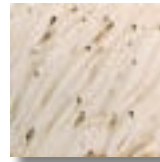

PCF-74 [TL] (River Birch)

Conforms to ASTM D-4236

The CL seal restricts this product from children under the age of 13. Older users must follow all cautionary labeling.



Conforms to ASTM D-4236

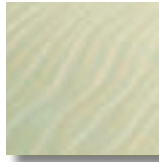

PCF-18 [TL] (Honeydew)



PCF-75 [TL] (Moss Mist)



Pot glazed with PCF-74 River Birch over C-29 Deep Sea.

NEW!

LEAD FREE CONE 5-6 "CO" HIGH FIRE COSMOS GLAZES FOR PORCELAIN & STONWARE



Conforms to ASTM D-4236

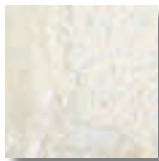

CO-6 [TL] (Supernova)

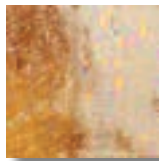

CO-7 [O] (Solar Flare)



CO-8 [O] (Dark Star)



CO-13 [O] (Mars Crystal)

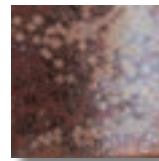

CO-14 [O] (Solar Rainbow)

*Food safe but not recommended for food surfaces due to durability.



Sculpture glazed with CO-8 Dark Star.

[O]=Opaque [TL]=Translucent

☞ Only glazes marked with the spray symbol may be used for safe spray application.

☑ Food Safe.

Tableware producers must have all finished ware tested and approved as safe for food through a certified laboratory due to possible variations in firing temperature and possible contamination. Standard Shipping Unit is 12 (16 oz.) and 4 (Gallons).

LEAD FREE (PCF) POTTER'S CHOICE FLUX GLAZES

NEW!

Cone 5-6.

AMACO® Potter's Choice Flux glazes are based on the widely popular PC-17 Honey Flux glaze. These glazes look beautiful on textured surfaces where the glazes can break and show the clay body color. Great for layering with Potter's Choice, Celadons or Shino glazes.

(AP) LEAD FREE (PCF) GLAZES

The Art & Creative Materials Institute AP (Approved Product) seal certifies this product to be safe for use by all ages.



| Series No. | Color | Pint Liquid Brushing Glazes | | Gallon Liquid Brushing Glazes | |
|------------|--------------|-----------------------------|---------|-------------------------------|---------|
| | | Cat. No. | Price | Cat. No. | Price |
| PCF-3 | Midnight Run | 35540D | \$21.00 | 35607G | \$94.00 |
| PCF-19 | Cirrus Flow | 35539C | \$21.00 | 35606F | \$94.00 |
| PCF-54 | Flux Blossom | 35541E | \$21.00 | 35608H | \$94.00 |
| PCF-74 | River Birch | 35542F | \$21.00 | | |



The CL seal restricts this product from children under the age of 13. Older users must follow all cautionary labeling.

| | | | | | |
|--------|-----------|--------|---------|--------|---------|
| PCF-18 | Honeydew | 35538B | \$21.00 | 35605E | \$94.00 |
| PCF-75 | Moss Mist | 35543G | \$21.00 | 35610J | \$94.00 |



Vase glazed with PCF-3 Midnight Run.

LEAD FREE (CO) COSMOS GLAZES

NEW!

Cone 5-6.

Crystalline effects right out of the jar without a hold or slow cool firing schedule. These beautiful iridescent colors have a tendency to run so protect your kiln shelves. Apply glaze to Cone 04 bisque, then glaze fire to Cone 5 or Cone 6.

(AP) LEAD FREE (CO) GLAZES

The Art & Creative Materials Institute AP (Approved Product) seal certifies this product to be safe for use by all ages.



| Series No. | Color | Pint Liquid Brushing Glazes | |
|------------|---------------|-----------------------------|---------|
| | | Cat. No. | Price |
| CO-6 | Supernova | 35550A | \$36.00 |
| CO-7 | Solar Flare | 35551B | \$36.00 |
| CO-8 | Dark Star | 35552C | \$36.00 |
| CO-13 | Mars Crystal | 35553D | \$36.00 |
| CO-14 | Solar Rainbow | 35554E | \$36.00 |



Vase glazed with CO-13 Mars Crystal.



GLAZES



LEAD FREE CONE 5-6 "SM" SATIN MATTE MID/HIGH FIRE GLAZES FOR PORCELAIN & STONEWARE



LEAD FREE CONE 5-6 "SH" SHINO MID/HIGH FIRE GLAZES FOR PORCELAIN & STONEWARE



[O]=Opaque

(FS) Only glazes marked with the spray symbol may be used for safe spray application.

(FS) Food Safe.

Tableware producers must have all finished ware tested and approved as safe for food through a certified laboratory due to possible variations in firing temperature and possible contamination. Standard Shipping Unit is 12 (16 oz.) and 4 (Gallons).

LEAD FREE (SM) SATIN MATTE GLAZES

Cone 5-6.

Satin Mattes break slightly over edges and texture, with a soft satin feel. These glazes are formulated to be 100% mixable. Use Clear Satin to lighten color tones.

(AP) LEAD FREE (SM) GLAZES

The Art & Creative Materials Institute AP (Approved Product) seal certifies this product to be safe for use by all ages.



| Series No. | Color | Pint Liquid Cat. No. | Price |
|------------|-----------------------|----------------------|---------|
| SM-1 | Black | 38200A | \$20.00 |
| SM-2 | Stone NEW! | 38215R | \$20.00 |
| SM-3 | Marble NEW! | 38216T | \$20.00 |
| SM-10 | Clear Satin | 38201B | \$20.00 |
| SM-11 | White | 38202C | \$20.00 |
| SM-20 | Light Blue | 38203D | \$20.00 |
| SM-21 | Dark Blue | 38204E | \$20.00 |
| SM-24 | Seafoam NEW! | 38217V | \$20.00 |
| SM-27 | Teal | 38206H | \$20.00 |
| SM-29 | Blue Green | 38214S | \$20.00 |
| SM-42 | Mint | 38209J | \$20.00 |
| SM-44 | Chartreuse | 38210K | \$20.00 |
| SM-46 | Moss NEW! | 38218W | \$20.00 |
| SM-51 | Red | 38211M | \$20.00 |
| SM-53 | Cayenne NEW! | 38219L | \$20.00 |
| SM-60 | Goldenrod NEW! | 38220X | \$20.00 |
| SM-63 | Yellow | 38212N | \$20.00 |
| SM-68 | Orange | 38213P | \$20.00 |



Planter glazed with Satin Matte glazes.

LEAD FREE (SH) SHINO GLAZES

Cone 5-6.

The Shino glazes yield wonderfully varied colors depending on their application thickness. A light application favors the warm rust base, a heavier application favors their opaque coloration. Textured surfaces enhance this effect. These glazes are formulated to be 100% mixable for color and finish.

(AP) LEAD FREE (SH) GLAZES

The Art & Creative Materials Institute AP (Approved Product) seal certifies this product to be safe for use by all ages.



| Series No. | Color | Pint Liquid Cat. No. | Price |
|------------|----------------|----------------------|---------|
| SH-11 | Chai Gloss | 39701A | \$20.00 |
| SH-12 | Chai Matte | 39702B | \$20.00 |
| SH-21 | Acai Gloss | 39703C | \$20.00 |
| SH-22 | Acai Matte | 39704D | \$20.00 |
| SH-31 | Cacao Gloss | 39705H | \$20.00 |
| SH-32 | Cacao Matte | 39706E | \$20.00 |
| SH-41 | Oolong Gloss | 39707F | \$20.00 |
| SH-42 | Oolong Matte | 39708L | \$20.00 |
| SH-45 | Matcha Gloss | 39709G | \$20.00 |
| SH-46 | Matcha Matte | 39710J | \$20.00 |
| SH-51 | Hibiscus Gloss | 39711K | \$20.00 |
| SH-52 | Hibiscus Matte | 39712M | \$20.00 |



Fruit bowls glazed with SH-46 Matcha Matte and SH-52 Hibiscus Matte.



LEAD FREE CONE 5-6 "HF" MID/HIGH FIRE HF-SERIES GLAZES FOR PORCELAIN & STONEWARE



Conforms to ASTM D-4236



HF-1 [O] [FS] Black

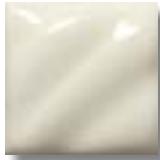

HF-9 [TP] [FS] Zinc-Free Clear

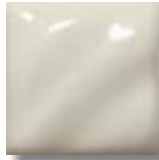

HF-10 [TP] [FS] Clear



HF-11 [O] [FS] White

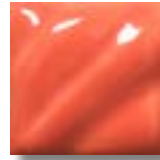

HF-55 [TL] [FS] Coral Gloss

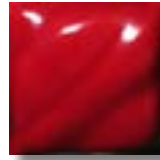

HF-56 [TL] [FS] Red Gloss

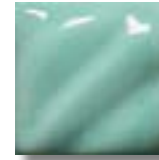

HF-125 [O] [FS] Turquoise

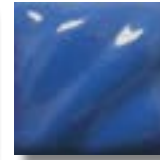

HF-127 [O] [FS] China Blue

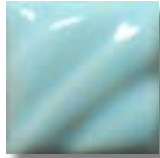

HF-129 [O] [FS] Baby Blue

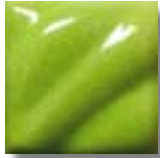

HF-142 [O] [FS] Chartreuse

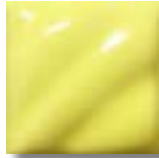

HF-161 [O] [FS] Bright Yellow

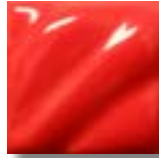

HF-165 [O] [FS] Scarlet Red

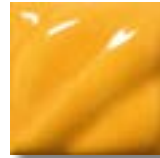

HF-166 [O] [FS] Orangerie

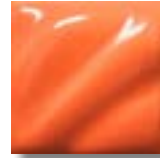

HF-167 [O] [FS] Clementine

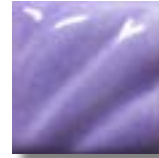

HF-170 [O] [FS] Lilac



HF-171 [O] [FS] Amethyst

The CL seal restricts this product from children under the age of 13. Older users must follow all cautionary labeling.



Conforms to ASTM D-4236

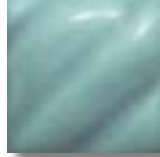

HF-26 [O] [FS] Sahara Turquoise

WARNING: HF-26 Sahara Turquoise can expose you to chemicals including Lithium carbonate, which are known to the State of California to cause birth defects or other reproductive harm. For more information go to www.P65Warnings.ca.gov.

LEAD FREE CONE 5-6 "TH-1" MID/HIGH FIRE TEXTURIZER FOR ACCENTING



Conforms to ASTM D-4236



TH-1 Over HF-1 Black



TH-1 Over HF-14 Oatmeal

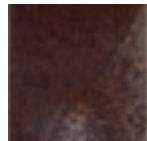

TH-1 Over HF-31 Rust Brown

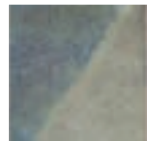

TH-1 Over PC-20 Blue Rutile

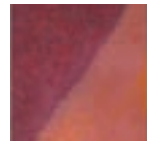

TH-1 Over PC-55 Chun Plum

[O]=Opaque [TP]=Transparent [TL]=Translucent

[FS] Only glazes marked with the spray symbol may be used for safe spray application.

[FS] Food Safe/

Sahara Glazes are recommended for utilitarian objects.

Tableware producers must have all finished ware tested and approved as safe for food through a certified laboratory due to possible variations in firing temperature and possible contamination. Standard Shipping Unit for liquid brushing glaze is 12 (16 oz.) and 4 (Gallons). Standard Shipping Unit for dry dipping glaze is 1.

LEAD FREE HF-SERIES GLAZES

Cone 5-6.

AMACO® HF-Series Glazes are made for stoneware but are as colorful as earthenware glazes. Apply glaze to Cone 04 (1971°F, 1077°C) bisque, then glaze fire to Cone 5 (2205°F, 1207°C) or Cone 6 (2269°F, 1243°C). The 25 lb. dry dipping glaze is packaged in a 5 gallon bucket for easy mixing.

(AP) LEAD FREE HF-SERIES GLAZES

The Art & Creative Materials Institute AP (Approved Product) seal certifies this product to be safe for use by all ages.



| Series No. | Color | Pint Liquid Brushing Glazes | | Gallon Liquid Brushing Glazes | |
|------------|-----------------|-----------------------------|---------|-------------------------------|---------|
| | | Cat. No. | Price | Cat. No. | Price |
| HF-1 | Black | 37000A | \$20.00 | | |
| HF-9 | Zinc-Free Clear | 37033P | \$20.00 | 37043D | \$84.00 |
| HF-10 | Clear | 37001B | \$20.00 | 37042C | \$84.00 |
| HF-11 | White | 37002C | \$20.00 | 37044E | \$84.00 |
| HF-55 | Coral Gloss | 37034R | \$36.00 | | |
| HF-56 | Red Gloss | 37035S | \$36.00 | | |
| HF-125 | Turquoise | 35505E | \$22.00 | | |
| HF-127 | China Blue | 35503A | \$32.50 | | |
| HF-129 | Baby Blue | 35506F | \$22.00 | | |
| HF-142 | Chartreuse | 35510M | \$32.50 | | |
| HF-161 | Bright Yellow | 35517W | \$32.50 | | |
| HF-165 | Scarlet Red | 35513P | \$36.00 | | |
| HF-166 | Orangerie | 35518A | \$36.00 | | |
| HF-167 | Clementine | 35514R | \$36.00 | | |
| HF-170 | Lilac | 35515T | \$36.00 | | |
| HF-171 | Amethyst | 35516V | \$36.00 | | |

The CL seal restricts this product from children under the age of 13. Older users must follow all cautionary labeling.

HF-26* Sahara Turquoise* 37011M \$20.00

*⚠️ **WARNING:** HF-26 Sahara Turquoise can expose you to chemicals including Lithium carbonate, which are known to the State of California to cause birth defects or other reproductive harm. For more information go to www.P65Warnings.ca.gov.

This color does not carry any seal but includes the wording "Conforms to ASTM D-4236".

| Series No. | Color | 25-lb Dry Dipping Glazes | |
|------------|------------------|--------------------------|----------|
| | | Cat. No. | Price |
| HF-9* | Zinc-Free Clear* | 37176H | \$178.00 |

*⚠️ **WARNING:** The dry form of HF-9 Zinc-Free Clear can expose you to chemicals including Silica, crystalline (airborne particles of respirable size), which are known to the State of California to cause cancer. For more information go to www.P65Warnings.ca.gov.



LEAD FREE (TH-1) TEXTURIZER

Cone 5-6.

This rutile base texturizer works over or under glazes. In superposition (overlying of glazes), it tends to produce a yellowish/orange crystal-type texture. It will yield excellent results when applied over most AMACO® HF Celebration, Sahara, and Potter's Choice glazes. Interesting, surprising colors and textures are possible. "Fix" glaze defects by hiding them beneath new color.

(AP) LEAD FREE (TH-1) TEXTURIZER

The Art & Creative Materials Institute AP (Approved Product) seal certifies this product to be safe for use by all ages.



| Series No. | Color | Pint Liquid Cat. No. | Price |
|------------|-----------------------------|----------------------|---------|
| TH-1 | Texturizer one pint, liquid | 37026G | \$15.80 |



GLAZES



Cups glazed with HF-Series glazes.

GLAZE ALTERATION AND REPAIR PRODUCTS/ACCESSORIES



GLAZES



Conforms to
ASTM D-4236

AMACO® SUSPENDAID

Brushing glazes may be altered to achieve the consistency of dipping and pouring glazes with the simple addition of water and AMACO® SuspendAid.

41323F 1 pint jar**\$14.25**
SSU=6



Conforms to
ASTM D-4236

AMACO® WAX RESIST

This wax emulsion, applied on greenware or bisque, "resists" application of glaze, slip, and underglaze.

41382A 1 pint jar**\$25.00**
SSU=6
41384C 1 gallon jar**\$115.00**
SSU=4



Conforms to
ASTM D-4236

AMACO® GUM SOLUTION

Old thick glazes can be brought back to their original creamy consistency by first thinning with water and then adding a tablespoon of AMACO® Gum Solution, or as much as is required, to obtain good brushing results.

41371N 1 pint jar**\$10.00**
SSU=6



AMACO® GLAZE CHIPS

Use Cone 04 bisque chips to test low-fire glazes before firing actual pieces. Glaze fire to Cone 05.

37587A each**\$0.70 NET**
SSU=1



AMACO® CERAMIC TILES

Decorate Cone 04 bisque tiles with AMACO® low fire glazes and underglazes. Glaze fire to Cone 05.

11334M 4¹/₄" x 4¹/₄" bisque**\$3.50**
SSU=72
11333L 6" x 6" bisque**\$5.30**
SSU=48

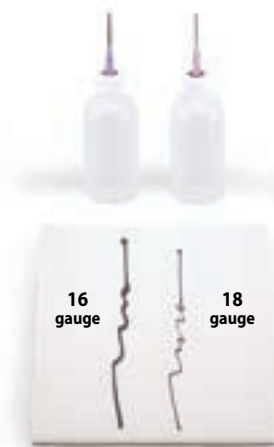

UNDERGLAZE APPLICATORS

Available in two needle sizes to allow you to make medium or fine lines, dots and letters on ceramic pieces.

2 oz. Underglaze Applicator
11263K 16 gauge**\$8.40**
11261G 18 gauge**\$8.40**
SSU=12

BRENT® ADAPTABLE WHEEL WITH CLASSIC CONTROL



BRENT® 16 WHEEL FEATURES:

- **Permanent magnet DC motor for high torque at all speeds**
- **6-Groove poly-v-belt drive with automatic tensioning**
Seamless belt stays tight for maximum performance and smooth operation
- **All-steel construction, solid steel table and durable poly cover**
Steel legs and table are powder-coated for corrosion and scratch-resistance
- **Durable cast aluminum foot pedal with 4 foot cord**
Delivers smooth control and speed range of 10-240 rpm
- **Machined cast aluminum 14" wheel head**
Marked with concentric circles and includes two bat pins
- **Splash Pan**
- **14" AMACO® Plasti-bat®**

BRENT® 16 ADAPTIVE FEATURES:

- **Adjustable**
Height of the throwing head adjusts from 21"-35" so wheel can be used while standing, with a stool, or from a wheelchair. Can accommodate a wheel chair 33½" wide at the base with a seated clearance of 12⅞"-26⅞".
- **Mobile**
Fits through any 36" door and rolls into position easily on its hard rubber casters
- **Stationary during throwing**
Four rubber feet raise the casters off the floor to hold wheel in place



BRENT® CLASSIC CONTROLLER FEATURES:

- **Electronic variable speed control for optimal torque at all speeds**
Wheel speed remains constant under varying loads
- **Quiet operation**
Electronic noise filtering for quiet operation
- **Easy-to-read indicator light**
Protrudes from control box for viewing from potter's stool
- **EZ-feel toggle switches are easy to locate**
On/off switch with additional forward/reverse switch
Forward/reverse has neutral/safety position for smooth transitions and use as banding wheel
- **Easy-to-switch modular connections for motor and foot pedal**

BRENT® 16 WHEEL

FITS THROUGH 36" DOORS

Handles 150 lbs. continuously, ½ hp, 5 amp motor, 70 dB(A)

| | | |
|--------|----------------------------------|------------|
| 22666E | Model 16 Wheel, 110-120V..... | \$4,700.00 |
| 22613P | Model 16 Wheel, 220-240V, €..... | \$4,775.00 |

SSU=1, Shipping Weight 310 lbs.



UNSURPASSED STRENGTH AND DURABILITY

MODEL 16 WHEEL 10 YEAR WARRANTY

Receive a \$100 Product Rebate from manufacturer with purchase.

To choose the most suitable wheel, see our wheel comparison chart on pages 48-49.

Shipping weights are approximate.



BRENT® WHEELS WITH CLASSIC CONTROL AND TEN YEAR WARRANTY

WHEELS & ACCESSORIES



BRENT® B WHEEL IDEAL FOR ANY CLASSROOM

Handles 150 lbs. continuously, 1/2 hp, 5 amp motor, 70 dB(A)

| | | |
|---------------|--|-------------------|
| 22604E | Model B Wheel, 110-120V..... | \$2,500.00 |
| 22606G | Model B Wheel, 220-240V, CE | \$2,525.00 |
| 22174W | Model B BLACK Wheel, 110-120V..... | \$2,550.00 |



SSU=1, Shipping Weight 130 lbs.



BRENT® C WHEEL IDEAL FOR ART CENTERS

Handles 225 lbs. continuously, 3/4 hp, 7 amp motor, 70 dB(A)

| | | |
|---------------|--|-------------------|
| 22608J | Model C Wheel, 110-120V..... | \$2,600.00 |
| 22610L | Model C Wheel, 220-240V, CE | \$2,625.00 |
| 22118V | Model C BLACK Wheel, 110-120V..... | \$2,650.00 |
| 22605F | Model C BLACK Wheel, 220-240V, CE | \$2,675.00 |



SSU=1, Shipping Weight 130 lbs.

UNSURPASSED STRENGTH AND DURABILITY
B AND C WHEELS 10 YEAR WARRANTY
 Receive a \$100 Product Rebate from manufacturer with purchase.

FILTERED SCR QUIET CONTROLLER WITH AUTO LOAD REGULATION FOR CONSTANT RPM



BRENT® WHEEL FEATURES:

- **Permanent magnet DC motor for high torque at all speeds**
- **6-Groove poly-v-belt drive with automatic tensioning**
Seamless belt stays tight for maximum performance and smooth operation
- **All-steel construction, solid steel table with durable poly cover**
Steel legs are powder-coated for corrosion and scratch-resistance
- **Durable cast aluminum foot pedal with 4 foot cord**
Delivers smooth control and speed range of 10-240 rpm
- **Splash Pan**
- **BRENT® B, C, CXC WHEELS:**
Includes a machined cast aluminum 14" wheel head and 14" AMACO® Plasti-bat®



BRENT® CLASSIC CONTROLLER FEATURES:

- **Electronic variable speed control for optimal torque at all speeds**
Wheel speed remains constant under varying loads
- **Quiet operation**
Electronic noise filtering for quiet operation
- **Easy-to-read indicator light**
Protrudes from control box for viewing from potter's stool
- **EZ-feel toggle switches are easy to locate**
On/off switch with additional forward/reverse switch
Forward/reverse has neutral/safety position for smooth transitions and use as banding wheel
- **Easy-to-switch modular connections for motor and foot pedal**

BRENT® CXC WHEEL IDEAL FOR PROFESSIONAL POTTERS

Handles 300 lbs. continuously, 1 hp, 10 amp motor, 70 dB(A)

| | | |
|--------|--|------------|
| 22727G | Model CXC Wheel, 110-120V | \$2,700.00 |
| 22728H | Model CXC Wheel, 220-240V, ☼ | \$2,750.00 |
| 22096X | Model CXC BLACK Wheel, 110-120V | \$2,775.00 |
| 22106K | Model CXC BLACK Wheel, 220-240V, ☼ | \$2,825.00 |

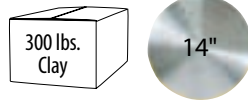

SSU=1, Shipping Weight 130 lbs.

UNSURPASSED STRENGTH AND DURABILITY CXC WHEELS 10 YEAR WARRANTY

Receive a \$100 Product Rebate from manufacturer with purchase.

To choose the most suitable wheel, see our wheel comparison chart on pages 48-49.

Shipping weights are approximate.



BATS FOR WHEELS



PLASTI-BAT® ALMOST INDESTRUCTIBLE!

Made of 1/4" thick rigid plastic, won't swell or shrink, easy to clean, and waterproof. Resistant to most chemicals.

Plasti-bat® with bat pin holes 10" apart on center.

- 32331K** 12" diameter **\$24.50**
- 32333M** 14" diameter **\$29.50**

SSU=12



SQUARE PLASTI-BAT®

9" square Plasti-Bat® (with pre-drilled pin holes 10" apart) increases shelf storage space. Fits standard wheelheads.

- 32344C** 9" x 9" **\$16.00**

SSU=12, Shipping Weight 13 lbs.

WHEEL ACCESSORIES



CANVAS COVERED BOARD

Each board is a portable clay work surface for wedging and rolling clay which can also be moved and stored easily. Keeps hand-built projects handy for many days. Absorbent canvas for water-based clays prevents sticking to work surfaces. Lightweight, 10" x 10" x 1/4" board.

- 32348L** 10" x 10" Canvas Covered Board..... **\$22.00**

SSU=6, Shipping Weight 5 lbs.

- 32349G** 10" x 10" Canvas Covered Board Kit, contains 10 boards..... **\$196.00**

SSU=1, Shipping Weight 8 1/2 lbs.



POTTER'S STOOL

18" high stool with 14" top and tempered hard-board seat.

- 22636T** Potter's Stool..... **\$122.00**

SSU=1, Shipping Weight 9 lbs.

BAT PINS

Package includes complete sets of bat pins to accommodate all years and models of brent® potter's wheels.

Includes (2) 1/2" bat pins, (2) 1 1/4" bat pins, and (2) wing nuts.

- 22135X** Bat Pins **\$16.25**

SSU=1

WHEEL HEAD AND LEG ACCESSORIES

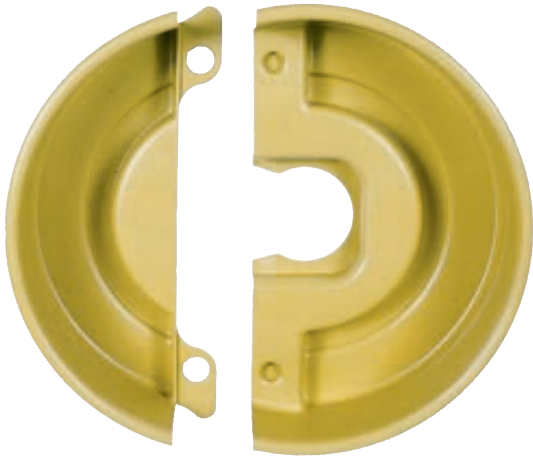

BRENT® SPLASH PAN

The Brent® Splash Pan made of polypropylene **snaps on** under the top bearing housing and fits all Brent® wheels. Catches excess water. Easily removed for cleaning.

22281F Gold Splash Pan.....**\$75.00**

SSU=1, Shipping Weight 4 lbs.



BRENT® BOOTIES

Set of three leg risers allow you to raise your wheel 2 or 4 inches. Fits all Brent® B, C, CXC, and EX wheels (also fits ie and ie-x models made after January, 2009).

22785E Brent® Booties (set of 3).....**\$61.00**

SSU=1, Shipping Weight 9 lbs.



LEG EXTENSION KIT

2 1/2" heavy gauge steel tubing makes this a strong, sturdy design with curved weight displacement for stabilization. Fits all Brent® B, C, CXC, and EX wheels (also fits ie and ie-x models made after January, 2009). Legs adjust from 32 1/2" to 37 1/2" in 1 1/2" increments. Also fits other wheel brands with 2 3/8" diameter leg tubes!

22927X Leg Extension Kit.....**\$385.00**

SSU=1, Shipping Weight 22 lbs.



BRENT® BLACK SPLASH PAN

Optional black splash pan fits all Brent® wheels.

22930B Black Splash Pan.....**\$75.00**

SSU=1, Shipping Weight 4 lbs.



BRENT® SLAB ROLLERS WITH ALL STEEL CONSTRUCTION

22601R



OPTIONAL

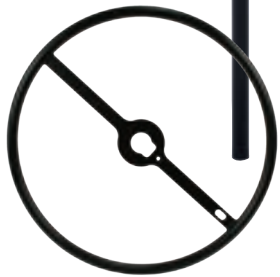

18, 6" x 6" tiles



Max slab dimensions:
21" w x 40" l, up to 1 1/4" thick

SRC SLAB ROLLER FOR HIGH SCHOOL, COLLEGE OR HOME STUDIO

| | |
|---|--|
| 22601R SRC WITH leg assembly, Includes: (1) 1/4" shim with canvas, (4) 1/4" shims plain, (1) 1/8" shim plain | \$1,775.00 SSU=1, Shipping Weight 207 lbs. |
| 22667F SRC WITHOUT leg assembly, Includes: (1) 1/4" shim with canvas, (4) 1/4" shims plain, (1) 1/8" shim plain | \$1,525.00 SSU=1, Shipping Weight 180 lbs. |
| 22668G SRC leg assembly | \$300.00 SSU=1, Shipping Weight 27 lbs. |
| 22652N 1/8" shim for SRC | \$32.00 SSU=1, Shipping Weight 7 lbs. |
| 22651M 1/4" shim for SRC | \$37.00 SSU=1, Shipping Weight 9 lbs. |
| 22650L 1/4" shim with canvas for SRC | \$93.00 SSU=1, Shipping Weight 11 lbs. |
| 22649K Top canvas for SRC | \$217.00 SSU=1, Shipping Weight 6 lbs. |
| 22694N Set of four replacement cables for SRC | \$105.00 SSU=1, Shipping Weight 1 lbs. |
| 22934E Round Handle (option) | \$261.20 |

SRC FEATURES

- Assembled dimensions: 40"w x 51"l x 40"h (height is with optional leg assembly)
- Portable table model becomes a floor model with optional leg set
- Maximum slab dimensions: 21" w x 40" l with 1 1/4" max. slab thickness

22600T

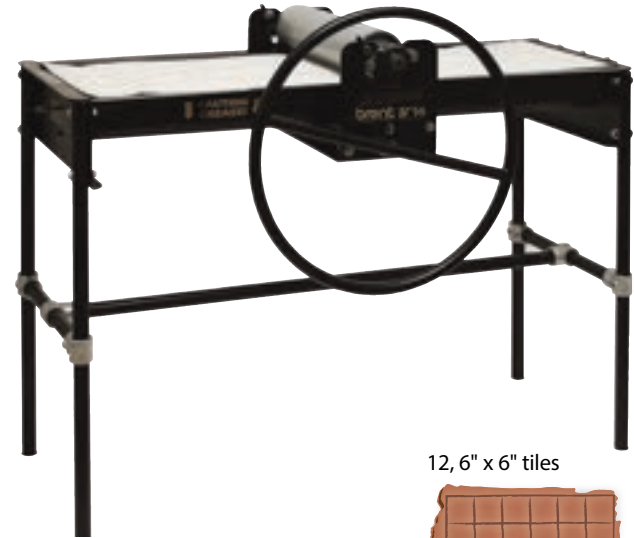

12, 6" x 6" tiles



Max slab dimensions:
14" w x 36" l, up to 1 3/4" thick

SR-14 SLAB ROLLER MIDSIZE FOR SCHOOL OR STUDIO

| | |
|--|--|
| 22600T SR-14 WITH leg assembly, Includes: (2) 1/4" shims with canvas, (1) 1/8" shim plain | \$3,200.00 SSU=1, Shipping Weight 245 lbs. |
| 22619Y SR-14 WITHOUT leg assembly, Includes: (2) 1/4" shims with canvas, (1) 1/8" shim plain | \$2,800.00 SSU=1, Shipping Weight 210 lbs. |
| 22620A SR-14 leg assembly | \$460.00 SSU=1, Shipping Weight 35 lbs. |
| 22523L 1/8" shim for SR-14 | \$32.00 SSU=1, Shipping Weight 5 lbs. |
| 22522K 1/4" shim with canvas for SR-14 | \$66.00 SSU=1, Shipping Weight 6 lbs. |
| 22149N Top canvas for SR-14 | \$238.00 SSU=1, Shipping Weight 4 lbs. |
| 22052N Set of replacement cables for SR-14 | \$131.00 SSU=1, Shipping Weight 2 lbs. |

SR-14 FEATURES

- Assembled dimensions: 27"w x 52"l x 40"h (height is with optional leg assembly)
- Large table model becomes a floor model with optional leg set
- Maximum slab dimensions: 14" w x 36" l with max. 1 3/4" slab thickness

Shipping weights are approximate.

OPPOSING ROLLERS PRODUCE EVEN SLABS

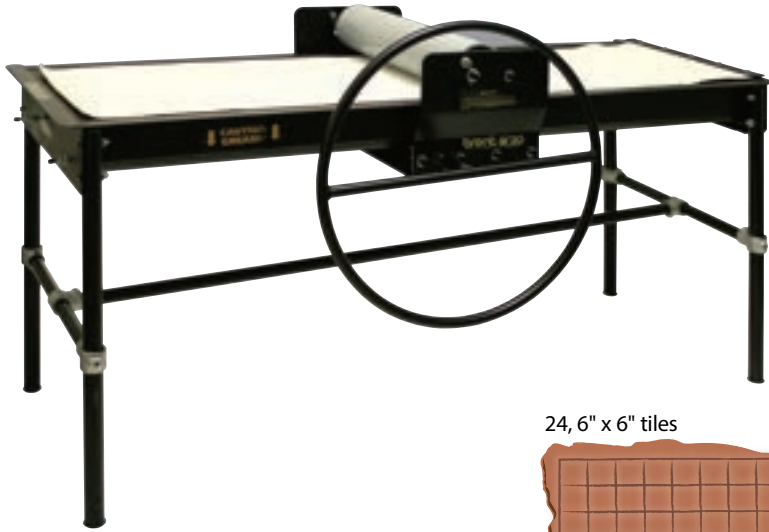

24, 6" x 6" tiles

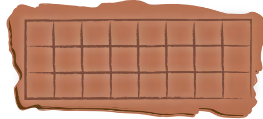

Max slab dimensions:
20"w x 52"l, up to 1½" thick



OPTIONAL



4, 6" x 6" tiles



Max slab dimensions:
14"w x 15"l, up to ¾" thick

SR-20 SLAB ROLLER

FIRST CHOICE IN SCHOOLS—BEST SELLER

| | | |
|---------------|---|--|
| 22621B | SR-20 Floor Model, Includes: (1) ¼" shim with canvas, (1) ⅛" shim plain..... | \$3,900.00 SSU=1, Shipping Weight 487 lbs. |
| 22526P | ⅛" shim for SR-20 | \$48.00 SSU=1, Shipping Weight 5 lbs. |
| 22527R | ¼" shim with canvas for SR-20..... | \$197.00 SSU=1, Shipping Weight 9 lbs. |
| 22150P | Top canvas for SR-20..... | \$260.00 SSU=1, Shipping Weight 6 lbs. |
| 22256A | Set of replacement cables for SR-20 | \$131.00 SSU=1, Shipping Weight 3 lbs. |

SR-20 SPECIFICATIONS

- Assembled dimensions: 34"w x 76"l x 40"h
- Produces slabs up to 20"w x 52"l with max. 1½" slab thickness

ALL brent® SLAB ROLLERS 1 YEAR WARRANTY

Receive \$70 Product Rebate from manufacturer
with purchase of Models SRC, SR-14 and SR-20.

Model Mini SRC is not eligible for rebate.

BRENT® MINI SRC SLAB ROLLER FOR SMALL STUDIO, SMALL PROJECTS

| | | |
|---------------|--|---|
| 22683B | Mini SRC, Includes: (1) ¼" shim with canvas, (2) ⅛" shims plain | \$1,175.00 SSU=1, Shipping Weight 85 lbs. |
| 22747G | ⅛" shim | \$32.00 SSU=1, Shipping Weight 2 lbs. |
| 22748H | ¼" shim with canvas..... | \$81.00 SSU=1, Shipping Weight 3 lbs. |
| 22688G | Top Canvas | \$93.00 SSU=1, Shipping Weight 7 lbs. |
| 22681X | Set of (4) replacement cables | \$90.00 SSU=1, Shipping Weight 1 lb. |
| 22933F | Round Handle (option) | \$198.50 |

MINI SRC SPECIFICATIONS

- Assembled dimensions: 31"w x 26"l x 14"h
- Portable table-top model
- Recommended for high school to adult
- Can be shipped UPS
- Produces slabs up to 14"w x 15"l with max. ¾" slab thickness





BRENT® CLAY EXTRUDER

FEATURES



Clutch Mechanism



Removable Barrel



End Cap Storage



BRENT® CLAY EXTRUDER HD

INCLUDES 3-PIECE DIE SET

Solid welded steel wall-mount extruder has 4" dia. barrel to hold 10 lbs. of clay.

ONE YEAR WARRANTY.

| | | |
|---------------|--------------------------------|-----------------|
| 22863X | Clay Extruder HD..... | \$920.00 |
| | SSU=1, Shipping Weight 46 lbs. | |
| 29305E | Replacement Vertical Pipe..... | \$59.00 |
| | SSU=1, Shipping Weight 4 lbs. | |

brent® CLAY EXTRUDER 1 YEAR WARRANTY

OPTIONAL MOUNTS



22025E

EXTRUDER TABLE/ WORKBENCH MOUNTING STAND

FOR CLAY EXTRUDER HD (22863X).

Mount your brent® Clay Extruder to any table/workbench. Instructions included. This mount requires drilling (3) holes into table/bench and brace will extend into workspace.

Not compatible with 22627H clay extruder model.

22025E Table Mount*..... **\$220.00**

* Requires drilling (3) holes into table/bench and brace will extend into workspace.

SSU=1, Shipping Weight 15 lbs.



22028J

EXTRUDER SLAB ROLLER MOUNTING STAND

FOR CLAY EXTRUDER HD (22863X).

Mount your brent® Clay Extruder to your brent® Slab Roller Models SR-14, SR-20, or SR-36. Instructions included.

Not compatible with 22627H clay extruder model.

22028J Slab Roller Mount (for models SR-14*, SR-20, SR-36) **\$245.00**

* For SR-14, requires use of SR-14 leg kit

SSU=1, Shipping Weight 17 lbs.

BRENT® CLAY EXTRUDER ACCESSORIES



BRENT® HOLLOW DIE SET

Create six (6) hollow or three (3) solid extrusions with this Hollow Die Set for brent® Clay Extruders.

22629K Hollow Die Set, metal..... **\$201.00**
SSU=1, Shipping Weight 5 lbs.



BRENT® STANDARD DIE SET

Create additional shapes with this 2-piece Standard Die Set with Selector for brent® Clay Extruders.

22628J Standard Die Set, metal.... **\$86.00**
SSU=1, Shipping Weight 2 lbs.

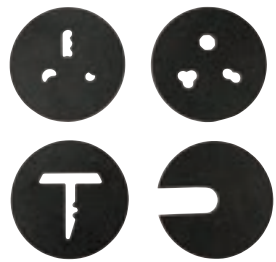

BRENT® 3-PIECE DIE SET

Create additional shapes with this 3-Piece Die Set with Selector for brent® Clay Extruders.

29309G 3-Piece Die Set
with selector, plastic..... **\$56.00**
SSU=1, Shipping Weight 1 lb.



BRENT® BLANK DIE

Create your own shape by cutting your own design into this Blank Die.

22677S Blank Die, plastic **\$10.60**
SSU=1, Shipping Weight 1 lb.

BRENT® CARTS



BRENT® SMARTCART™

BY DESIGNING WOMEN/ART TEACHERS!

22867C SmartCart™..... **\$990.00**
SSU=1, Shipping Weight 85 lbs.

SMARTCART™ FEATURES

- Swivel/locking casters
- Can be stored away in closets
- Retractable shelf slides right or left
- Holds the brent® SRC Mini Slab Roller on top
- Assembled dimensions: 27"w x 24 1/2"d x 34"h



Top shelf has four pre-drilled holes to secure the brent® Mini SRC Slab Roller.

brent® SMARTCART™ 1 YEAR WARRANTY

brent® SmartCart™ can be shipped UPS.

BRENT® CARTS



Bats not included.



Welded and Bolted Joints



Bolted Spanner Bars



Welded and Bolted Joints

BRENT® BATMOBILE NOW INCLUDES BATBRACE™

22066J Batmobile with BatBrace™ **\$775.00**

SSU=1, Shipping Weight 54 lbs.

BRENT® BATBRACE™

22119C BatBrace™ bookend for bats, holds 50 Plasti-bats **\$23.50**

SSU=1, Shipping Weight 1 lb.

BATMOBILE FEATURES

- Welded construction for added strength and weight capacity
- Self-locking bolts & nuts (for easy assembly)
- 1-person assembly
- Powder coated steel frame
- Stores up to 90 (14" diameter) bats
- Includes brent® BatBrace™
- 4" diameter locking rubber swivel casters
- Adjustable top rails
- Assembled dimensions: 47³/₄"w x 36"h x 14¹/₂"d

BRENT® KILN SHELF CART

11779F Kiln Shelf Cart with shelves **\$900.00**

SSU=1, Shipping Weight 65 lbs.

KILN SHELF CART FEATURES

- Welded joints for added strength and weight capacity
- Self-locking bolts & nuts (for easy assembly)
- 1-person assembly
- Powder coated steel frame
- Three storage shelves
- Steel rods to store 16 shelves maximum height 20"
- 4" diameter locking rubber swivel casters
- Assembled dimensions: 47³/₄"h x 36"l x 14¹/₂"w

ALL brent® CARTS 1 YEAR WARRANTY

All brent® Carts can be shipped UPS.

BRENT® CARTS



Ware Cart and Shelves sold together or separately.

BRENT® WARE CART EX

THE STRONGEST, MOST VERSATILE WARE CART

| | | |
|---------------|---|---------------------------------|
| 22633P | Ware Cart EX with Plastic Cover (no shelves)..... | \$950.00 |
| | | SSU=1, Shipping Weight 90 lbs. |
| 22832J | Ware Cart EX with set of (12) plywood shelves and plastic cover | \$1,125.00 |
| | | SSU=1, Shipping Weight 127 lbs. |
| 22634R | Set of (12) plywood shelves | \$195.00 |
| | | SSU=1, Shipping Weight 47 lbs. |
| 22827F | Ware Cart Replacement Cover | \$.950 |
| | | SSU=1, Shipping Weight 2 lbs. |

WARE CART EX FEATURES

- **Top/bottom frame supports**
bolt into place
- **1" steel pipe and welded shelf supports**
- **Powder coated frame**
for greater durability and improved scratch and corrosion resistance
- **Heavy duty, swivel and locking casters**
offer stability and easy maneuvering
- **Easy assembly**
one person can assemble alone
- **9 shelf supports**
for greater stacking versatility
- **Assembled dimensions: 72³/₄"h x 35"w x 24"d**
- **Optional set of (6 or 12) shelves**
12" x 32" x 1/2" exterior plywood
- **Durable plastic cover**

brent® WARE CART EX 1 YEAR WARRANTY





brent® Ware Cart EX can be shipped UPS.

Shipping weights are approximate.





BRENT WHEEL COMPARISON CHART

| Wheel Model Photos are shown to scale for size comparison. | Capacity | Motor | Dimensions | | Shipping Weight (approximate) | RPM/ Speed | Drive |
|---|-------------------------------------|--|------------------------|------------------------|----------------------------------|------------------------|-------|
| | | | Assembled | Shipping | | | |
| B  | Continuously handles 150 lbs. | Permanent Magnet, DC 1/2 HP 5 amps | 21"w x 28"d x 21 1/2"h | 24"w x 31"d x 24"h | 130 lbs. | Variable 10-240 rpm | Belt |
| C  | Continuously handles 225 lbs. | Permanent Magnet, DC 3/4 HP 7 amps | 21"w x 28"d x 21 1/2"h | 24"w x 31"d x 24"h | 130 lbs. | Variable 10-240 rpm | Belt |
| CXC  | Continuously handles 300 lbs. | Permanent Magnet, DC 1 HP 10 amps | 21"w x 28"d x 21 1/2"h | 24"w x 31"d x 24"h | 130 lbs. | Variable 10-240 rpm | Belt |
| 16  | Continuously handles 150 lbs. | Permanent Magnet, DC 1/2 HP 5 amps | 38"w x 46"d x 36"h | 41"w x 48 1/2"d x 41"h | 310 lbs. | Variable 10-240 rpm | Belt |

BRENT WHEEL COMPARISON CHART

| Voltage | dB(A) | Wheel Head | Shaft Bore | Price | Special Features | Wheel Model |
|----------------------------|-------|-------------------------------|------------|--|---|-------------|
| 110-120V 220-240V | 70 | 14" Aluminum with Bat Pins | 3/4" | 110-120V 22604E—\$2,500.00 BLACK 110-120V 22174W—\$2,550.00 220-240V 22606G—\$2,525.00 | Solid steel table, brent® Classic Controller with forward/reverse switch, automatic belt tensioning, 6-groove poly-v-belt drive, durable cast aluminum foot pedal, splash pan, AMACO® 14" Plasti-bat®, machined cast aluminum 14" wheel head, TEN YEAR WARRANTY. | B |
| 110-120V 220-240V | 70 | 14" Aluminum with Bat Pins | 3/4" | 110-120V 22608J—\$2,600.00 BLACK 110-120V 22118V—\$2,650.00 220-240V 22610L—\$2,625.00 BLACK 220-240V 22605F—\$2,675.00 | Solid steel table, brent® Classic Controller with forward/reverse switch, automatic belt tensioning, 6-groove poly-v-belt drive, durable cast aluminum foot pedal, splash pan, AMACO® 14" Plasti-bat®, machined cast aluminum 14" wheel head, TEN YEAR WARRANTY. | C |
| 110-120V 220-240V | 70 | 14" Aluminum with Bat Pins | 3/4" | 110-120V 22727G—\$2,700.00 BLACK 110-120V 22096X—\$2,775.00 220-240V 22728H—\$2,750.00 BLACK 220-240V 22106K—\$2,825.00 | Solid steel table, brent® Classic Controller with forward/reverse switch, automatic belt tensioning, 6-groove poly-v-belt drive, durable cast aluminum foot pedal, splash pan, AMACO® 14" Plasti-bat®, machined cast aluminum 14" wheel head, TEN YEAR WARRANTY. | CXC |
| 110-120V 220-240V DC | 70 | 14" Aluminum with Bat Pins | 3/4" | 110-120V 22666E—\$4,700.00 220-240V 22613P—\$4,775.00 | Wheel chair accessible, wheel head adjusts from 21" to 35" in height, fits through any 36" door, four hard rubber casters for mobility, four rubber feet raise casters off the floor for stability while throwing, welded steel frame, high density 1" side tables with laminate surface, brent® Classic Controller with reverse option, hand lever/foot pedal, 6-groove poly-v-belt drive, splash pan, AMACO® 14" Plasti-bat®, machined cast aluminum 14" wheel head, TEN YEAR WARRANTY. | 16 |





EXCEL® KILNS TO FIT SMALL BUDGETS AND SMALL SPACES

EX-232

FIRES TO CONE 10 (2381°F, 1305°C)

2 1/2" firebrick

3.2 cubic foot firing chamber capacity

Firing chamber dimensions:

17 1/2" diameter, 22" deep

Exterior dimensions:

29"w x 22 1/2"d x 36"h

(width includes control box, height includes stand)

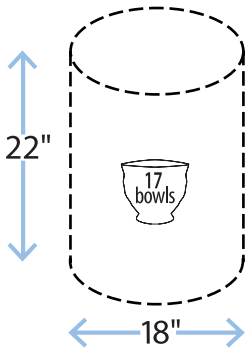

EX-232 shown with Select Fire™ controller.

EX-329

FIRES TO CONE 10 (2381°F, 1305°C)

3" firebrick

2.9 cubic foot firing chamber capacity

Firing chamber dimensions:

16 1/2" diameter, 22" deep

Exterior dimensions:

29"w x 22 1/2"d x 36"h

(width includes control box, height includes stand)

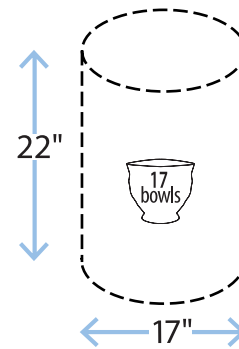

EX-329 shown with Select Fire™ controller.

EX-232 AND EX-329 FEATURES

- **Versatile firing range**
Cone 022-10
- **Select Fire™ Computer Control** (See page 60)
- **Reinforced steel bar**
Secures lid while loading and unloading
- **Modular design**
EXCEL® kilns consist of two or more sections that allow the kiln to be quickly disassembled for easy element or brick replacement, or for moving through narrow openings
- **Reversible slabs**
Lid and bottom slabs can be turned over, extending the life of the kiln
- **Stainless steel jackets**
Allow for proper expansion and contraction during firing
- **5 high quality Kanthal A-1 element wire coils**
- **7-foot, 50 amp power cord with NEMA 6-50 plug**
- **Steel stand with no-mar rubber feet**
- **Corrosion-resistant lug connectors**
Replacing elements is easy using just a screwdriver

See page 71 for electrical requirements and amperage ratings.



Every EXCEL® kiln features a two-position, reinforced steel bar to secure lid while loading and unloading.

Select Fire™ Controller is standard on EX-232SF and EX-329SF. Basic or complex firing programs are easy to enter with user friendly prompts.



EX-232SF Kiln with Select Fire™ Controller

| | | |
|---------------|-------------------------|-------------------|
| 25154S | Single Phase, 208V..... | \$3,800.00 |
| 25153N | Single Phase, 240V..... | \$3,800.00 |

SSU=1, Shipping Weight 165 lbs.

EX-329SF Kiln with Select Fire™ Controller

| | | |
|---------------|-------------------------|-------------------|
| 25156R | Single Phase, 208V..... | \$4,350.00 |
| 25155P | Single Phase, 240V..... | \$4,350.00 |

SSU=1, Shipping Weight 180 lbs.



Kiln ventilation for the EX-232 and EX-329

Master KilnVent

(For photo and additional information, see page 62)

| | | |
|---------------|-----------------------------|-------------------|
| 29968J | Master Kiln Vent, 110V..... | \$826.00 |
| 29983D | Master Kiln Vent, 240V..... | \$1,207.00 |

SSU=1, Shipping Weight 10½ lbs.



KILNS

ALL EXCEL® KILNS 2 YEAR WARRANTY



See pages 63 for available kiln shelves for these models.

Shipping weights are approximate.



EXCEL® KILNS TO FIT SMALL BUDGETS AND SMALL SPACES

EX-257

FIRES TO CONE 10 (2381°F, 1305°C)

2 1/2" firebrick

5.7 cubic foot firing chamber capacity

Firing chamber dimensions:

23 1/2" diameter, 22" deep

Exterior dimensions:

35"w x 28 1/2"d x 36"h

(width includes control box, height includes stand)

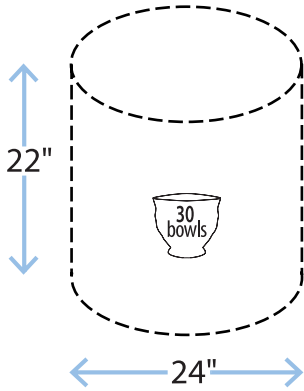

EX-257 shown with Select Fire™ controller and EZ-Lift.

EX-353

FIRES TO CONE 10 (2381°F, 1305°C)

3" firebrick

5.25 cubic foot firing chamber capacity

Firing chamber dimensions:

22 1/2" diameter, 22" deep

Exterior dimensions:

35"w x 28 1/2"d x 36"h

(width includes control box, height includes stand)

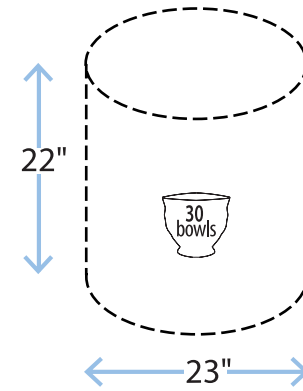

EX-353 shown with Select Fire™ controller and EZ-Lift.

EX-257 AND EX-353 FEATURES

- **Versatile firing range**
Cone 022-10
- **Select Fire™ Computer Control** (See page 60)
- **EZ-Lift Spring-Assisted Lid**
Heavy duty spring loaded hinge means effortless opening and closing
- **Reinforced steel bar**
Secures lid while loading and unloading
- **Modular design**
EXCEL® kilns consist of two or more sections that allow the kiln to be quickly disassembled for easy element or brick replacement, or for moving through narrow openings
- **Reversible slabs**
Lid and bottom slabs can be turned over, extending the life of the kiln
- **Stainless steel jackets**
Allow for proper expansion and contraction during firing
- **5 high quality Kanthal A-1 element wire coils**
- **7-foot, 50 amp power cord**
NEMA 6-50 plug (single phase) or NEMA 15-50 plug (three phase)
- **Steel stand with no-mar rubber feet**
- **Corrosion-resistant lug connectors**
Replacing elements is easy using just a screwdriver

See page 71 for electrical requirements and amperage ratings.



EZ-Lift, a spring-assisted hinge, makes the lid lighter so you can lift it with a finger.

Select Fire™ Controller is standard on EX-257SF and EX-353SF. Basic or complex firing programs are easy to enter with user friendly prompts.



EX-257SF Kiln with Select Fire™ Controller and EZ-Lift

| | | |
|---------------|-------------------------|-------------------|
| 25158W | Single Phase, 208V..... | \$4,850.00 |
| 25157V | Single Phase, 240V..... | \$4,850.00 |
| 25160T | Three Phase, 208V..... | \$4,850.00 |
| 25159X | Three Phase, 240V..... | \$4,850.00 |

SSU=1, Shipping Weight 290 lbs.

EX-353SF Kiln with Select Fire™ Controller and EZ-Lift

| | | |
|---------------|-------------------------|-------------------|
| 25162B | Single Phase, 208V..... | \$5,150.00 |
| 25161A | Single Phase, 240V..... | \$5,150.00 |
| 25164D | Three Phase, 208V..... | \$5,150.00 |
| 25163C | Three Phase, 240V..... | \$5,150.00 |

SSU=1, Shipping Weight 320 lbs.



Kiln ventilation for the EX-257 and EX-353

Master KilnVent

(For photo and additional information, see page 62)

| | | |
|---------------|-----------------------------|-------------------|
| 29968J | Master Kiln Vent, 110V..... | \$826.00 |
| 29983D | Master Kiln Vent, 240V..... | \$1,207.00 |

SSU=1, Shipping Weight 10 1/2 lbs.

See pages 63 for available kiln shelves for these models.

All EXCEL® KILNS 2 YEAR WARRANTY



Shipping weights are approximate.



KILNS



EXCEL® FITS SMALL SPACES

EX-381

FIRES TO:

CONE 10 (2381°F, 1305°C)—208V THREE PHASE; 240V SINGLE OR THREE PHASE

CONE 8 (2320°F, 1271°C)—208V SINGLE PHASE

3" firebrick

8.1 cubic foot firing chamber capacity

Firing chamber dimensions:

28" diameter, 22" deep

Exterior dimensions:

40½"w x 34"d x 36"h

(width includes control box, height includes stand)

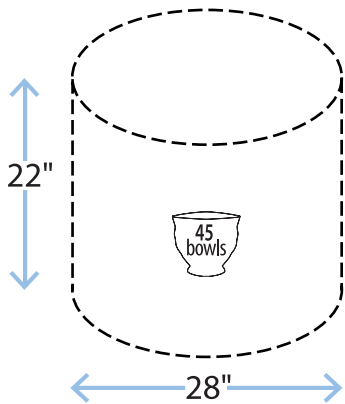

EX-381 shown with Select Fire™ controller and EZ-Lift.

EXCEL® MEDIUM/LARGE CAPACITY KILN

EX-1266SF

FIRES TO CONE 10 (2381°F, 1305°C)

2½" firebrick

6.6 cubic foot firing chamber capacity

Firing chamber dimensions: 28" diameter, 18" deep

Exterior dimensions: 38"w x 33"d x 34"h with EZ-Lift

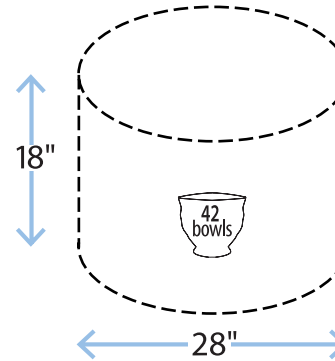

EX-1266SF shown with Select Fire™ and EZ-Lift as standard equipment.

*Model EX-381 single phase, 208V has a maximum temperature of Cone 8.

EX-381 AND EX-1266SF FEATURES

- **Select Fire™ Computer Control** (See page 60)
- **EZ-Lift Spring-Assisted Lid**
Heavy duty spring loaded hinge means effortless opening and closing
- **Reinforced steel bar**
Secures lid while loading and unloading
- **Modular design**
EXCEL® kilns consist of two or more sections that allow the kiln to be quickly disassembled for easy element or brick replacement, or for moving through narrow openings
- **Reversible slabs**
Lid and bottom slabs can be turned over, extending the life of the kiln
- **Stainless steel jackets**
Allow for proper expansion and contraction during firing
- **Steel stand with no-mar rubber feet**
- **Corrosion-resistant lug connectors**
Replacing elements is easy using just a screwdriver

EX-381 SPECIFICATIONS

- **Versatile firing range**
Cone 022-10 (208V three phase, 240V single or three phase)
Cone 022-8 (208V single phase)
- **5 high quality Kanthal A-1 element wire coils**
- **7-foot, 50 amp power cord**
NEMA 6-50 plug (single phase) or NEMA 15-50 plug (three phase)

EX-1266SF SPECIFICATIONS

- **7-foot, 50 amp power cord with NEMA 6-50 plug**
- **4 high quality Kanthal A-1 element wire coils**
- **Versatile firing range**
Cone 022-10

See pages 73 and 75 for electrical requirements and amperage ratings.



EZ-Lift, a spring-assisted hinge, makes the lid lighter so you can lift it with a finger.

Select Fire™ Controller is standard on EX-381SF and EX-1266SF. Basic or complex firing programs are easy to enter with user friendly prompts.



See pages 63 for available kiln shelves for these models.

EX-381SF Kiln with Select Fire™ Controller and EZ-Lift

| | | |
|---------------|-------------------------|-------------------|
| 25166F | Single Phase, 208V..... | \$5,650.00 |
| 25165E | Single Phase, 240V..... | \$5,650.00 |
| 25168L | Three Phase, 208V..... | \$5,650.00 |
| 25167G | Three Phase, 240V..... | \$5,650.00 |

SSU=1, Shipping Weight 365 lbs.



EX-1266SF Kiln with Select Fire™ Controller and EZ-Lift

| | | |
|---------------|-------------------------|-------------------|
| 25145E | Single Phase, 208V..... | \$5,450.00 |
| 25146F | Single Phase, 240V..... | \$5,450.00 |

SSU=1, Shipping Weight 355 lbs.



Kiln ventilation for the EX-381 and EX-1266SF

Master KilnVent

(For photo and additional information, see page 62)

| | | |
|---------------|-----------------------------|-------------------|
| 29968J | Master Kiln Vent, 110V..... | \$826.00 |
| 29983D | Master Kiln Vent, 240V..... | \$1,207.00 |

SSU=1, Shipping Weight 10 1/2 lbs.

EZ-Lift Kit for EX-1266SF

Installs on 12-sided EXCEL® kilns purchased without EZ-Lift.

| | | |
|---------------|--------------------------------|-----------------|
| 25147G | EZ-Lift Kit for EX-1266SF..... | \$721.00 |
|---------------|--------------------------------|-----------------|

SSU=1, Shipping Weight 25 lbs.

All EXCEL® KILNS 2 YEAR WARRANTY



Shipping weights are approximate.



KILNS



KILNS

EXCEL® LARGE CAPACITY KILNS WITH SMALL FOOTPRINTS

EX-365

FIRES TO CONE 10 (2381°F, 1305°C)

3" firebrick

6.57 cubic foot firing chamber capacity

Firing chamber dimensions: 22³/₈" diameter, 27" deep

Exterior dimensions: 35"w x 31"d x 42³/₄"h with EZ-Lift

EX-270

FIRES TO:

CONE 10 (2381°F, 1305°C)–208V THREE PHASE; 240V SINGLE OR THREE PHASE

CONE 6 (2269°F, 1243°C)–208V SINGLE PHASE

2¹/₂" firebrick

7 cubic foot firing chamber capacity

Firing chamber dimensions: 23³/₈" diameter, 27" deep

Exterior dimensions: 35"w x 31"d x 42³/₄"h with EZ-Lift

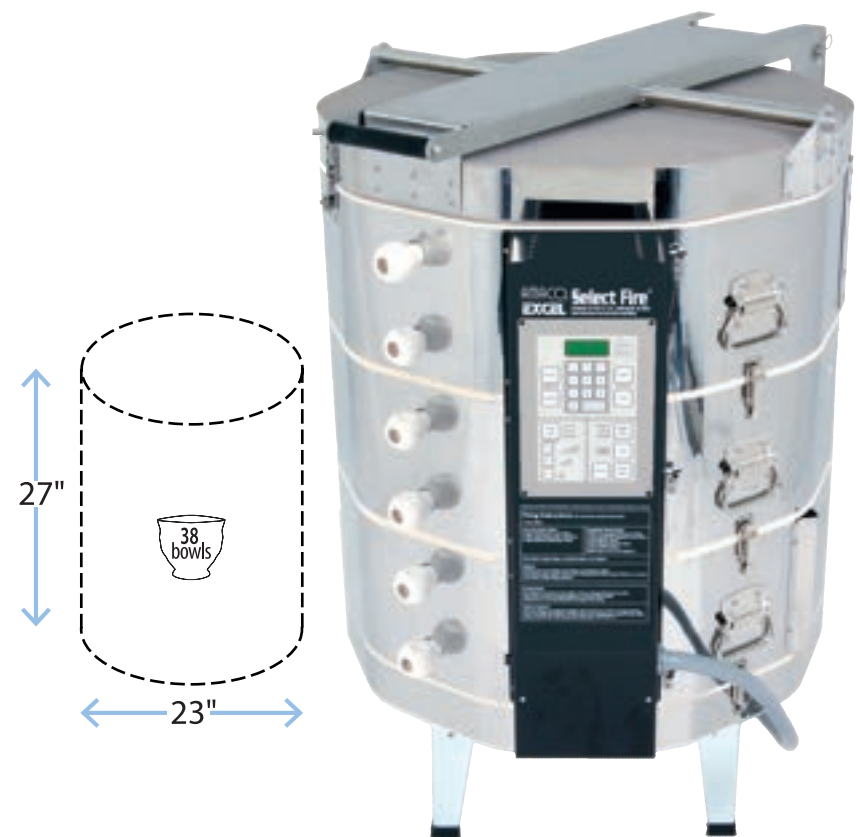
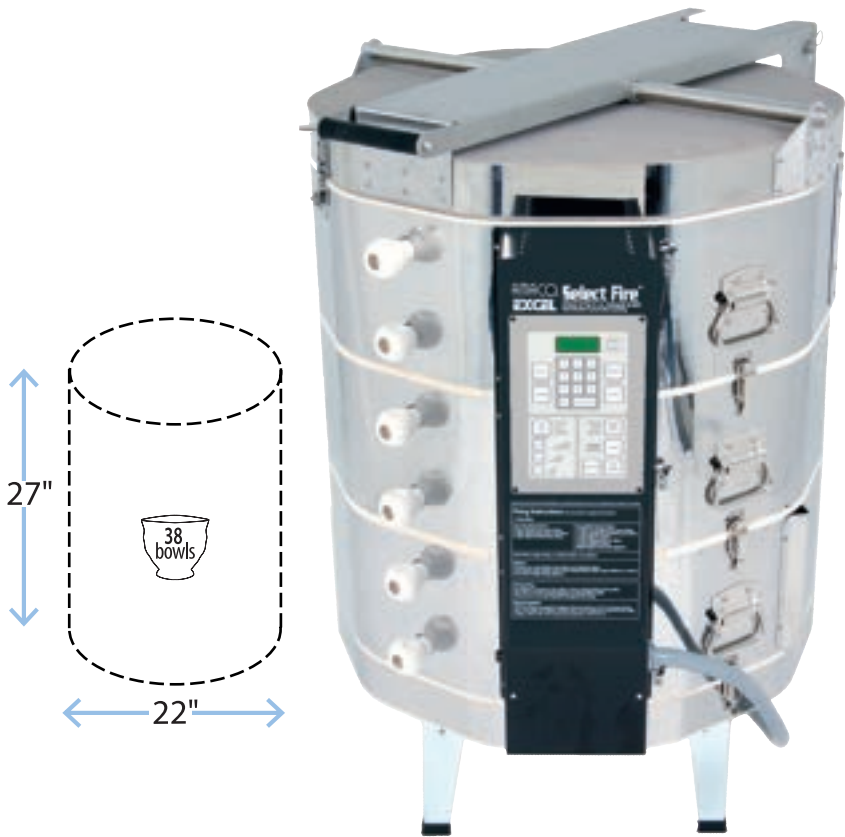

EX-365 shown with Select Fire™ controller and optional EZ-Lift spring assisted lid.

EX-270 shown with Select Fire™ controller and optional EZ-Lift spring assisted lid.

EX-365 AND 270 FEATURES

- **Versatile firing range**
EX-365—Cone 022-10
EX-270—Cone 022-10 (208V three phase, 240V single or three phase)
Cone 022-6 (208V single phase)
- **Select Fire™ Computer Control** (See page 60)
- **EZ-Lift Spring-Assisted Lid**
Heavy duty spring loaded hinge means effortless opening and closing
- **Reinforced steel bar**
Secures lid while loading and unloading
- **Modular design**
EXCEL® kilns consist of two or more sections that allow the kiln to be quickly disassembled for easy element or brick replacement or moving through narrow openings
- **Reversible slabs**
Lid and bottom slabs can be turned over, extending the life of the kiln
- **Stainless steel jackets**
Allow for proper expansion and contraction during firing
- **6 high quality Kanthal A-1 element wire coils**
- **7-foot, 50 amp power cord**
With NEMA 6-50 plug (single phase) or NEMA 15-50 plug (three phase)
- **Steel stand with no-mar rubber feet**
- **Corrosion-resistant lug connectors**
Replacing elements is easy using just a screwdriver

See page 73 for electrical requirements and amperage ratings.

EZ-Lift Kit for EX-270 and EX-365

Installs on 10-sided EXCEL® kilns purchased without EZ-Lift.

| | | |
|---------------|------------------------------|-----------------|
| 25148L | EZ-Lift Kit for EX-270 | \$688.00 |
| 25149B | EZ-Lift Kit for EX-365 | \$688.00 |

SSU=1, Shipping Weight 25 lbs.



The EX-270 and EX-365 are available with EZ-Lift, a spring-assisted hinge that makes the lid lighter so you can lift it with a finger.



Optional on the EX-365, Zone Control uses three thermocouples during firing to maintain even temperatures throughout the kiln chamber.

EX-365SF Kiln with Select Fire™ Controller and EZ-Lift

| | | |
|---------------|-------------------------|-------------------|
| 25113N | Single Phase, 208V..... | \$5,400.00 |
| 25114P | Single Phase, 240V..... | \$5,400.00 |
| 25115R | Three Phase, 208V..... | \$5,400.00 |
| 25116T | Three Phase, 240V..... | \$5,400.00 |

SSU=1, Shipping Weight 320 lbs.

EX-270SF Kiln with Select Fire™ Controller and EZ-Lift

| | | |
|---------------|-------------------------|-------------------|
| 25105E | Single Phase, 208V..... | \$5,600.00 |
| 25106F | Single Phase, 240V..... | \$5,600.00 |
| 25107G | Three Phase, 208V..... | \$5,600.00 |
| 25108J | Three Phase, 240V..... | \$5,600.00 |

SSU=1, Shipping Weight 290 lbs.

RECEIVE
\$100
EX-270/365

IN AMACO® GLAZES
WITH PURCHASE.

Kiln ventilation for the EX-270 and EX-365

Master KilnVent

(For photo and additional information, see page 62)

| | | |
|---------------|-----------------------------|-------------------|
| 29968J | Master Kiln Vent, 110V..... | \$826.00 |
| 29983D | Master Kiln Vent, 240V..... | \$1,207.00 |

SSU=1, Shipping Weight 10 1/2 lbs.

All EXCEL® KILNS 2 YEAR WARRANTY



See pages 63 for available kiln shelves for these models.

Shipping weights are approximate.



KILNS

EXCEL® EXTRA LARGE CAPACITY KILNS WITH MODULAR COMPONENTS



KILNS

EX-399SF

FIRES TO:

CONE 8 (2320°F, 1271°C)–208V THREE PHASE; 240V SINGLE OR THREE PHASE

CONE 5 (2205°F, 1207°C)–208V SINGLE PHASE

3" firebrick

9.92 cubic foot firing chamber capacity

Firing chamber dimensions: 28" diameter, 27" deep

Exterior dimensions: 38"w x 33"d x 43"h with EZ-Lift

EX-1099SF

FIRES TO CONE 10 (2381°F, 1305°C)

3" firebrick

9.92 cubic foot firing chamber capacity

Firing chamber dimensions: 28" diameter, 27" deep

Exterior dimensions: 38"w x 33"d x 43"h with EZ-Lift

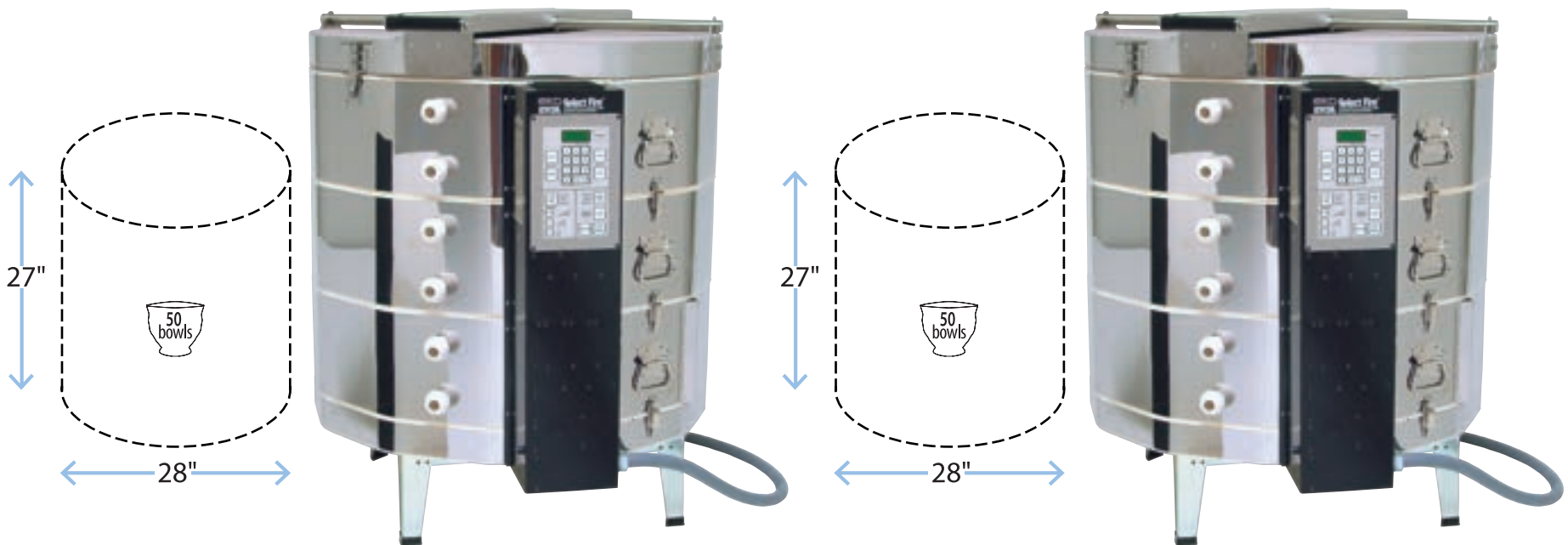

EX-399 shown with Select Fire™ controller.

EX-1099 shown with Select Fire™ controller.

EX-399SF AND EX-1099SF FEATURES

- **Versatile firing range**
EX-1099SF—Cone 022-10
EX-399SF—Cone 022-8 (208V three phase, 240V single or three phase)
Cone 022-5 (208V single phase)
- **7-foot, 50 amp power cord**
EX-1099SF—Direct Wire
EX-399SF—NEMA 6-50 plug (single phase) or NEMA 15-50 plug (three phase)
- **Select Fire™ Computer Control** (See page 60)
- **EZ-Lift Spring-Assisted Lid**
Heavy duty spring loaded hinge means effortless opening and closing
- **Reinforced steel bar**
Secures lid while loading and unloading
- **Modular design**
EXCEL® kilns consist of two or more sections that allow the kiln to be quickly disassembled for easy element or brick replacement or moving through narrow openings
- **Reversible slabs**
Lid and bottom slabs can be turned over, extending the life of the kiln
- **Stainless steel jackets**
Allow for proper expansion and contraction during firing
- **6 high quality Kanthal A-1 element wire coils**
- **Steel stand with no-mar rubber feet**
- **Corrosion-resistant lug connectors**
Replacing elements is easy using just a screwdriver

See page 75 for electrical requirements and amperage ratings.

EZ-Lift Kit

Installs on 12-sided EXCEL® kilns purchased without EZ-Lift.

25147G EZ-Lift Kit for EX-399/1099SF **\$721.00**

SSU=1, Shipping Weight 25 lbs.



EZ-Lift, a spring-assisted hinge, makes the lid lighter so you can lift it with a finger.



Optional on the EX-1099SF, Zone Control uses three thermocouples during firing to maintain even temperatures throughout the kiln chamber.

See pages 63 for available kiln shelves for these models.

Shipping weights are approximate.

EX-399SF Kiln with Select Fire™ Controller and EZ-Lift

| | | |
|---------------|-------------------------|-------------------|
| 25137V | Single Phase, 208V..... | \$6,000.00 |
| 25138W | Single Phase, 240V..... | \$6,000.00 |
| 25139S | Three Phase, 208V..... | \$6,000.00 |
| 25140B | Three Phase, 240V..... | \$6,000.00 |

SSU=1, Shipping Weight 400 lbs.



EX-1099SF Kiln with Select Fire™ Controller and EZ-Lift

| | | |
|---------------|-------------------------|-------------------|
| 25141X | Single Phase, 208V..... | \$6,950.00 |
| 25142A | Single Phase, 240V..... | \$6,950.00 |
| 25143C | Three Phase, 208V..... | \$6,950.00 |
| 25144D | Three Phase, 240V..... | \$6,950.00 |

SSU=1, Shipping Weight 410 lbs.



Kiln ventilation for the EX-399SF/EX-1099SF

Master KilnVent

(For photo and additional information, see page 62)

| | | |
|---------------|-----------------------------|-------------------|
| 29968J | Master Kiln Vent, 110V..... | \$826.00 |
| 29983D | Master Kiln Vent, 240V..... | \$1,207.00 |

SSU=1, Shipping Weight 10½ lbs.



KILNS

All EXCEL® KILNS 2 YEAR WARRANTY



SELECT FIRE™ CONTROLLERS SOLD SEPARATELY

SELECT FIRE™ KILN CONTROL FEATURES

- **Digital Readout**
Shows prompts, messages, and temperature throughout firing and cool down
- **Touchpad**
Smooth surface pads are easy to clean and have no moving parts
- **Delay Options**
Lets you delay start of firing
- **Alarm**
You can set alarm to sound at any temperature
- **Cone Fire Mode**
Lets you fire by simply entering the desired Cone number
- **Firing Speeds**
Choose from Slow, Medium, or Fast heating
- **Menu**
Allows access to 4 sub menus for programming and diagnostic options
- **Action Controls**
Lets you start or stop kiln operation
- **Ramp/Hold Mode**
Lets you select up to eight segments of temperature change and hold
- **View Current Segment**
Shows you what Ramp/Hold segment the kiln is currently in
- **Cone Table**
Converts Cone numbers to temperature
- **Review**
Reviews your current firing program



SELECT FIRE™ WALL MOUNT

Designed for existing AMACO® or EXCEL® kilns, a Select Fire™ provides firing accuracy.

| | |
|--|-------------------|
| 24122S Single Phase, 208-240V AC | \$2,360.00 |
| 24123T Three Phase, 208-240V AC | \$2,472.00 |

SSU=1, Shipping Weight 12 lbs.



SELECT FIRE™ WITH ZONE CONTROL

The Select Fire™ with Zone Control uses three thermocouples to sense temperature variation between the sections and sends a signal to energize the elements in the cooler section and bring it up to temperature with the other sections.

Zone Control is special order for kiln models EX-365SF and EX-10999SF.

| | |
|--|-----------------|
| 24133G Zone Control option installed | \$577.00 |
|--|-----------------|

SSU=1

Please allow 6-8 weeks for manufacturing.

Designed and manufactured in the U.S.A. under license from the Edward J. Orton Jr. Ceramics Foundation.

KILN CONTROLLERS AND GAUGES



KILN-SITTER® WITH LIMIT TIMER

UL Listed. A junior size cone mounted horizontally in the Kiln-Sitter® activates the electrical switch and turns the kiln off automatically. When adding to a kiln for the first time, a Wiring Kit is required. The Limit Timer is a clock dial which can be set for a specified number of hours. It functions as an added safety factor to prevent overfiring. Detailed installation and operating instructions are supplied with each instrument.

To ensure receipt of proper model, please specify wall depth of kiln (including brick, insulation, outside metal), trade name, model no., voltage, phase, and amperage.

LT-3 Model with Limit Timer

28741B Single Phase, 208, 240 Volts \$440.00

LT-3K Model with Limit Timer for EXCEL Kilns only, flush mount style.

28782C Single Phase, 208, 240 Volts \$432.00

LT-3 Model with Limit Timer and Relay

28739Y Three Phase, 208, 240 Volts \$440.00

SSU=1

NOTE: If replacing a Kiln-Sitter®, you may not need a new wiring kit.

IF YOU ARE EXPERIENCING UNDERFIRING WHEN USING A KILN-SITTER WITH LIMIT TIMER DURING THE FIRING OF AMACO® CLAYS AND GLAZES, USE ONE CONE HIGHER.



THERMOCOUPLES

A thermocouple is a sensor which measures temperatures.

Complete Thermocouple For AMACO® Kilns with Select Fire® AH-25, AH-10, FA-44, and FA-88

28845T 12½" Thermocouple with 72" lead wire..... \$102.00

AH-30

28846V 14" Thermocouple with 72" lead wire \$102.00

HF and EC series

28847X 9½" Thermocouple with 72" lead wire \$92.00

SSU=1

Replacement Thermocouple with yellow plug for Select Fire® Wall Mount Controller.

28817N 8" replacement thermocouple..... \$169.00

SSU=1

Thermocouple for discontinued analog pyrometer for AMACO® Kilns: 62-EFC, 64-E, 67-EFC, EC-15, EC-26 and MK-4

28840N 7" Thermocouple with 24" lead wire..... \$48.00

SSU=1

Thermocouple for AMACO® Kilns with Manual Controls

EC-55 and HF-97

28841P 7" Thermocouple with 36" lead wire..... \$54.00

HF-101 and HF-105

28842B 7" Thermocouple with 48" lead wire..... \$60.50

AH-10

28844S 9½" Thermocouple with 72" lead wire \$72.00

SSU=1

Replacement element for thermocouple for AMACO® Kilns with Select Fire®: HF and EC series.

28848W 9½" replacement element \$76.40

Replacement element for all EXCEL® Kiln Thermocouples.

28815L 6" replacement element..... \$43.50

SSU=1



KILNS



KILN ACCESSORIES



AMACO® MASTER KILNVENT

FOR ALL CURRENT AND DISCONTINUED AMACO® AND EXCEL® KILN MODELS.

Mounts to wall then connects to the bottom, back, or top of kiln. The 1.1 amp motor runs on 120V, has a static pressure of 0.2, and is 72 CFM.

| | | |
|---------------|-----------------------------|-------------------|
| 29968J | Master KilnVent, 110V | \$826.00 |
| 29983D | Master KilnVent, 240V | \$1,207.00 |

SSU=1, Shipping Weight 15 lbs.

AMACO® MASTER KILNVENT 2 YEAR WARRANTY

BENEFITS OF USING A KILN VENT

- **Truer colors**
Draws in room air to add oxygen needed for reds, greens, golds, and yellows. Colors are brighter, more vibrant, and can be fired together.
- **Safer work area**
Unvented kilns exceed OSHA levels for carbon monoxide within the kiln room. A Kiln Vent mixes hot gas from kiln with room air to safely vent outdoors a now cooled exhaust.
- **More uniform temperatures**
Circulates hot gasses in kiln so items at the bottom or top of the kiln receive the same heat.
- **Fewer firing problems**
Oxygen brought into kilns helps burn out carbon and organics in bodies and glazes reducing crazing, pinholing, and porcelain mildew.

U.S. Patent No. 4,863,374 and 4,978,295
The Edward J. Orton Jr. Ceramic Foundation



BRENT® KILN SHELF CART

Powder coated steel frame with locking swivel casters. Steel rods store (16) kiln shelves (up to 20"). Includes three storage shelves. Welded bottom support rails offer added stability. Assembled dimensions: 47³/₄"h x 36"l x 14¹/₂"w.

| | | |
|---------------|-----------------------|-----------------|
| 11779F | Kiln Shelf Cart | \$900.00 |
|---------------|-----------------------|-----------------|

SSU=1, Shipping Weight 63 lbs.

brent® KILN SHELF CART 1 YEAR WARRANTY
brent® Kiln Shelf Cart can be shipped UPS

EXCEL® KILN SHELVES



FULL OCTAGON REFRACTORY KILN SHELVES

EXCEL® Kilns EX-226, EX-232 ; AMACO® Kilns JS-26, JS-39; P-6; AS-1809, AS-1813, AS-1822

11371G 15¹/₂" x 15¹/₂" x ⁵/₈", Cone 10, each**\$51.00**
SSU=1, Shipping Weight 10 lbs.

EXCEL® Kilns EX-324, EX-329

11379R 15" x 15" x ⁵/₈", Cone 1, each**\$79.00**
SSU=1, Shipping Weight 13 lbs.

HALF OCTAGON REFRACTORY KILN SHELVES

EXCEL® Kilns EX-399, EX-1099SF, EX-1266SF, EX-381, EX-1850SF; AMACO® Kiln AS-2929

11373J 26" x 13" x 1", Cone 10, each.....**\$99.00**
SSU=1, Shipping Weight 22 lbs.

EXCEL® Kilns EX-226, EX-232; AMACO® Kilns JS-26, JS-39; P-6; AS-1809, AS-1813, AS-1822

11374K 15¹/₂" x 7³/₄" x ⁵/₈", Cone 10, each.....**\$29.00**
SSU=1, Shipping Weight 7 lbs.

EXCEL® Kilns EX-399, EX-1099SF, EX-1266SF, EX-381, EX-1850SF; AMACO® Kiln AS-2929

11377N 26" x 13" x ⁵/₈", Cone 1, each**\$90.00**
SSU=1, Shipping Weight 15 lbs.

EXCEL® Kilns EX-324, EX-329

11380M 15" x 7¹/₂" x ⁵/₈", Cone 1, each**\$47.00**
SSU=1, Shipping Weight 7 lbs.

HALF ROUND REFRACTORY KILN SHELVES

EXCEL® Kilns EX-270, EX-247, EX-257; AMACO® Kilns P-8, P-10; JS-43, JS-65; AS-2427

11361R 21" x 10¹/₂" x ³/₄", Cone 10, each**\$56.00**
SSU=1, Shipping Weight 10 lbs.

EXCEL® Kilns EX-344, EX-365, EX-353

11378P 19" x 9¹/₂" x ⁵/₈", Cone 10, each.....**\$47.00**
SSU=1, Shipping Weight 9 lbs.

AMACO® KILN SHELVES



SQUARE REFRACTORY KILN SHELVES

AMACO® Kilns 62-EFC, 62-E

11346A 6" x 6" x ¹/₂", Cone 06, each.....**\$15.00**
SSU=1, Shipping Weight 1 lb.

AMACO® Kilns 67-EFC, 67-E, EC-15, EC-35, HF-65, HF-66

11348C 9" x 9" x ¹/₂", Cone 06, each.....**\$27.00**
SSU=1, Shipping Weight 3 lbs.

AMACO® Kilns EC-55, HF-95, HF-96, HF-97, HF-101

11355K 16" x 16" x ³/₄", Cone 1, each**\$61.00**
SSU=1, Shipping Weight 11 lbs.

RECTANGULAR REFRACTORY KILN SHELVES

AMACO® Kilns EC-55, HF-95, HF-96, HF-97, HF-101, HF-105

11354J 16" x 8" x ⁵/₈", Cone 1, each.....**\$39.00**
SSU=1, Shipping Weight 6 lbs.



KILNS

The maximum temperature for kiln shelves varies and are noted above. Shelves and posts can be custom stacked for each firing to maximize kiln space.



AMACO® SHELF SUPPORTS

These Mullite Props and Shelf Supports are strong, durable, and will withstand temperatures up to Cone 10 (2381°F, 1305°C).

Single Shelf Supports

| | | |
|---------------|---------------------------------|---------------|
| 11302C | 1 5/8" x 1 5/8" x 1" each | \$2.75 |
| 11303D | 1 5/8" x 1 5/8" x 2" each | \$3.05 |
| 11304E | 1 5/8" x 1 5/8" x 3" each | \$3.30 |
| 11318E | 1" x 1" x 4" each..... | \$3.35 |
| 11344R | 1 5/8" x 1 5/8" x 4" each | \$4.00 |
| 11345T | 1 5/8" x 1 5/8" x 5" each | \$4.20 |
| 11320W | 1" x 1" x 6" each..... | \$4.80 |
| 11349D | 1 5/8" x 1 5/8" x 6" each | \$5.20 |
| 11353H | 1 5/8" x 1 5/8" x 7" each | \$5.30 |
| 11357M | 1 5/8" x 1 5/8" x 8" each | \$5.40 |
| 11332P | 1 5/8" x 1 5/8" x 10" each..... | \$7.25 |

SSU=1



AMACO® PLATE SETTER

One set of three fires one plate. Additional sets interlock and stack to fire up to six plates. Cone 6 (2269°F, 1243°C) maximum.

| | | |
|---------------|----------|----------------|
| 11300A | Set..... | \$18.00 |
|---------------|----------|----------------|

SSU=1, Shipping Weight 1 lb.

KILN ACCESSORIES



POINTED STILT KITS

Three metal alloy points embedded in stoneware base leave no mark on fired pieces. Measurements given are distance between prongs. Cone 04 (1971°F, 1077°C) maximum.

Kits contain various shapes and sizes of stoneware stilts (see chart below).

| | | |
|---------------|--|-----------------|
| 11287L | Small Stilt Kit (30 assorted stilts)..... | \$117.00 |
|---------------|--|-----------------|

SSU=1, Shipping Weight 2 lbs.

| | | |
|---------------|--|-----------------|
| 11288M | Large Stilt Kit (60 assorted stilts)..... | \$208.00 |
|---------------|--|-----------------|

SSU=1, Shipping Weight 6 lbs.

| Stilt No. | Pt. to Pt. | Small Kit Contains | Large Kit Contains |
|----------------------|-------------------------|--------------------|--------------------|
| A-00 | 1/4"..... | 3..... | 0..... |
| A-0 | 1/2"..... | 3..... | 6..... |
| A-1 | 3/4"..... | 3..... | 6..... |
| A-2 | 1 1/4"..... | 3..... | 6..... |
| A-4 | 1 1/2"..... | 3..... | 6..... |
| A-6 | 2 1/4"..... | 3..... | 6..... |
| A-8 | 2 3/4"..... | 1..... | 3..... |
| A-10 | 3 1/2"..... | 1..... | 3..... |
| B-2x9 | 1 1/4"..... | 1..... | 2..... |
| B-4x6 | 1 1/2"..... | 1..... | 2..... |
| B-6x12 | 2 1/4"..... | 1..... | 2..... |
| B-10x15 | 3 1/2"..... | 0..... | 1..... |
| C-12x15 | 4 1/4"..... | 0..... | 1..... |
| C-14x9 | 5 1/4"..... | 0..... | 1..... |
| D-3B | 3 1/4" long..... | 3..... | 6..... |
| D-4B | 4" long..... | 3..... | 6..... |
| E-2S | 1 3/4", 1 1/2" rod..... | 0..... | 1..... |
| F-6H | 1 3/8" x 1 3/4" hi..... | 1..... | 2..... |
| | | 30 | 60 |



11403R

11404S

GENERAL DUTY GLOVES

Made from cowhide with cotton lining, foam back, and wing thumb. Withstands temperatures up to 450°F (232°C). Partially sewn with Kevlar® thread.

| | | |
|---------------|---------------------------------|----------------|
| 11403R | Ladies (Extra Small), pair..... | \$23.00 |
|---------------|---------------------------------|----------------|

| | | |
|---------------|------------------------|----------------|
| 11404S | Men (Large), pair..... | \$23.00 |
|---------------|------------------------|----------------|

SSU=1

Refractory setters or stilts are available in various shapes and sizes to maximize kiln space and prevent artwork from sticking to kiln shelves and kiln shelf wash.

KILN ACCESSORIES



Conforms to
ASTM D-4236

AMACO® KILN CEMENT

Cracks and chips in kiln refractory can be permanently sealed with AMACO® Kiln Cement. **WARNING:** Do not allow direct contact with elements and electrical wiring.

The CL seal restricts this product from children under the age of 13. Older users must follow all cautionary labeling.

41374R Moist, 1-lb jar **\$18.10**
SSU=12



Conforms to
ASTM D-4236

AMACO® KILN SHELF WASH

Glaze drippings are easy to remove when the shelf is coated with Kiln Shelf Wash.

52776K 1 lb. jar **\$9.60**
SSU=12

52777L 4-lb carton **\$27.50**
SSU=6



CERAMIC PEEPHOLE PLUGS

Replacement peephole plugs for all EXCEL®, Crusader, Gold Standard™, and Silver round kilns.

28583X Ceramic peephole plugs **\$16.00**
SSU=1



AMACO
CLASSROOM.COM
INTRODUCES...

KILN BASICS

FIRE YOUR KILN
WITH CONFIDENCE!

A resource for beginning
ceramic teachers, or pros
who need a refresher course.

VISIT TODAY!



Scan me to go to
AMACOClassroom.com



KILNS



KILNS

EXCEL[®] KILN ELEMENTS

| Kiln No. | Code No. | Part Description | No. Per Kiln | Price Each |
|------------------|----------|--|--------------|------------|
| EX-226 | 24001B | Element Coil, 208 Volts | 4 | \$97.00 |
| EX-226 | 24000A | Element Coil, 240 Volts | 4 | \$97.00 |
| EX-226SF | 24034R | Top or Bottom Element Coil, 208 Volts | 2 | \$97.00 |
| EX-226SF | 24036T | Top or Bottom Element Coil, 240 Volts | 2 | \$97.00 |
| EX-226SF | 24033N | Center Element Coil, 208 Volts | 2 | \$97.00 |
| EX-226SF | 24035P | Center Element Coil, 240 Volts | 2 | \$97.00 |
| EX-232SF | 24164V | Top or Bottom Element Coil, 208 Volts, Single Phase | 2 | \$130.00 |
| EX-232SF | 24162S | Top or Bottom Element Coil, 240 Volts, Single Phase | 2 | \$130.00 |
| EX-232SF | 24165W | Center Element Coil, 208 Volts, Single Phase | 3 | \$130.00 |
| EX-232SF | 24163T | Center Element Coil, 240 Volts, Single Phase | 3 | \$130.00 |
| EX-247, EX-247SF | 24009K | Top or Bottom Element Coil, 208 Volts | 2 | \$121.00 |
| EX-247, EX-247SF | 24007H | Top or Bottom Element Coil, 240 Volts | 2 | \$121.00 |
| EX-247, EX-247SF | 24010L | Center Element Coil, 208 Volts | 2 | \$121.00 |
| EX-247, EX-247SF | 24008J | Center Element Coil, 240 Volts | 2 | \$121.00 |
| EX-257SF | 24065R | Top or Bottom Element Coil, 208 Volts, Single or Three Phase | 2 | \$130.00 |
| EX-257SF | 24057C | Top or Bottom Element Coil, 240 Volts, Single or Three Phase | 2 | \$130.00 |
| EX-257SF | 24066D | Center Element Coil, 208 Volts, Single or Three Phase | 3 | \$130.00 |
| EX-257SF | 24058D | Center Element Coil, 240 Volts, Single or Three Phase | 3 | \$130.00 |
| EX-270, EX-270SF | 24004E | Top or Bottom Element Coil, 208 Volts, Single or Three Phase | 2 | \$121.00 |
| EX-270, EX-270SF | 24002C | Top or Bottom Element Coil, 240 Volts | 2 | \$121.00 |
| EX-270, EX-270SF | 24005F | Center Element Coil, 208 Volts, Single Phase | 4 | \$121.00 |
| EX-270, EX-270SF | 24006G | Center Element Coil, 208 Volts, Three Phase | 4 | \$121.00 |
| EX-270, EX-270SF | 24003D | Center Element Coil, 240 Volts | 4 | \$121.00 |
| EX-324 | 24012N | Element Coil, 208 Volts | 4 | \$98.00 |
| EX-324 | 24011M | Element Coil, 240 Volts | 4 | \$98.00 |
| EX-324SF | 24038V | Top or Bottom Element Coil, 208 Volts | 2 | \$98.00 |
| EX-324SF | 24040X | Top or Bottom Element Coil, 240 Volts | 2 | \$98.00 |
| EX-324SF | 24037S | Center Element Coil, 208 Volts | 2 | \$98.00 |
| EX-324SF | 24039W | Center Element Coil, 240 Volts | 2 | \$98.00 |
| EX-329SF | 24108N | Top or Bottom Element Coil, 208 Volts, Single Phase | 2 | \$130.00 |
| EX-329SF | 24099R | Top or Bottom Element Coil, 240 Volts, Single Phase | 2 | \$130.00 |
| EX-329SF | 24157L | Center Element Coil, 208 Volts, Single Phase | 3 | \$130.00 |
| EX-329SF | 24100S | Center Element Coil, 240 Volts, Single Phase | 3 | \$130.00 |

SSU=1

| Kiln No. | Code No. | Part Description | No. Per Kiln | Price Each |
|------------------|----------|--|--------------|------------|
| EX-344, EX-344SF | 24015S | Top or Bottom Coil, 208 Volts | 2 | \$120.00 |
| EX-344, EX-344SF | 24013P | Top or Bottom Element Coil, 240 Volts | 2 | \$120.00 |
| EX-344, EX-344SF | 24016T | Center Coil, 208 Volts | 2 | \$120.00 |
| EX-344, EX-344SF | 24014R | Center Element Coil, 240 Volts | 2 | \$120.00 |
| EX-353SF | 24092J | Top or Bottom Element Coil, 208 Volts, Single or Three Phase | 2 | \$130.00 |
| EX-353SF | 24090H | Top or Bottom Element Coil, 240 Volts, Single or Three Phase | 2 | \$130.00 |
| EX-353SF | 24093K | Center Element Coil, 208 Volts, Single or Three Phase | 3 | \$130.00 |
| EX-353SF | 24091G | Center Element Coil, 240 Volts, Single or Three Phase | 3 | \$130.00 |
| EX-365, EX-365SF | 24019X | Top or Bottom Element Coil, 208 Volts | 2 | \$128.00 |
| EX-365, EX-365SF | 24017V | Top or Bottom Element Coil, 240 Volts | 2 | \$128.00 |
| EX-365, EX-365SF | 24020Y | Center Element Coil, 208 Volts, Single Phase | 4 | \$128.00 |
| EX-365, EX-365SF | 24026F | Center Element Coil, 208 Volts, Three Phase | 4 | \$128.00 |
| EX-365, EX-365SF | 24018W | Center Element Coil, 240 Volts | 4 | \$128.00 |
| EX-381SF | 24096N | Top or Bottom Element Coil, 208 Volts, Single Phase | 2 | \$130.00 |
| EX-381SF | 24098T | Top or Bottom Element Coil, 208 Volts, Three Phase | 2 | \$130.00 |
| EX-381SF | 24094L | Top or Bottom Element Coil, 240 Volts, Single or Three Phase | 2 | \$130.00 |
| EX-381SF | 24097P | Center Element Coil, 208 Volts, Single or Three Phase | 3 | \$130.00 |
| EX-381SF | 24095M | Center Element Coil, 240 Volts, Single or Three Phase | 3 | \$130.00 |
| EX-399, EX-399SF | 24023C | Top or Bottom Element Coil, 208 Volts | 2 | \$130.00 |
| EX-399, EX-399SF | 24021A | Top or Bottom Element Coil, 240 Volts | 2 | \$130.00 |
| EX-399, EX-399SF | 24024D | Center Element Coil, 208 Volts, Single Phase | 4 | \$130.00 |
| EX-399, EX-399SF | 24025E | Center Element Coil, 208 Volts, Three Phase | 4 | \$130.00 |
| EX-399, EX-399SF | 24022B | Center Element Coil, 240 Volts | 4 | \$130.00 |
| EX-1099SF | 24028H | Intermediate Element Coil, 208 Volts | 2 | \$121.00 |
| EX-1099SF | 24027G | Intermediate Element Coil, 240 Volts | 2 | \$121.00 |
| EX-1099SF | 24029J | Center Element Coil, 208 Volts | 2 | \$121.00 |
| EX-1099SF | 24030K | Center Element Coil, 240 Volts | 2 | \$121.00 |
| EX-1099SF | 24031M | Top or Bottom Element Coil, 208 Volts | 2 | \$121.00 |
| EX-1099SF | 24032L | Top or Bottom Element Coil, 240 Volts | 2 | \$121.00 |
| EX-1099SF | | APM Element—Call for information and price quotation | | |

SSU=1

Element Wire Pins For All EXCEL[®] Kilns

32325D Kanthal A-1 Wire Pins, per dozen**\$35.00**

EXCEL® KILN ELEMENTS

| Kiln No. | Code No. | Part Description | No. Per Kiln | Price Each |
|-----------|--|---|--------------|------------|
| EX-1266SF | 24055P | Top or Bottom Element Coil, 208 Volts | 2 | \$130.00 |
| EX-1266SF | 24053N | Top or Bottom Element Coil, 240 Volts | 2 | \$130.00 |
| EX-1266SF | 24054S | Center Element Coil, 208 Volts | 2 | \$130.00 |
| EX-1266SF | 24056R | Center Element Coil, 240 Volts | 2 | \$130.00 |
| EX-1850SF | 24047G | Top or Bottom Element Coil, 208 Volts, Three Phase* | 4 | \$114.00 |
| EX-1850SF | 24048L | Top or Bottom Element Coil, 240 Volts, Three Phase* | 4 | \$120.00 |
| EX-1850SF | 24051K | Intermediate Element Coil, 208 Volts, Three Phase* | 4 | \$114.00 |
| EX-1850SF | 24052M | Intermediate Element Coil, 240 Volts, Three Phase* | 4 | \$120.00 |
| EX-1850SF | 24049H | Center Element Coil, 208 Volts, Three Phase* | 4 | \$114.00 |
| EX-1850SF | 24050J | Center Element Coil, 240 Volts, Three Phase* | 4 | \$120.00 |
| EX-1850SF | APM Element—Call for information and price quotation | | | |

SSU=1

*Single phase kiln elements are available for Kiln EX-1850SF as a special order only.

INFORMATION SHIPPED WITH EACH EXCEL® KILN

A wiring diagram, parts list, and Kiln Operating manual is included with each EXCEL® kiln sold. Complete information regarding operation, maintenance, and use is included. Duplicate copies are available by calling (800) 374-1600. The following PDFs are also available on our website, amaco.com:

1. EXCEL® Kiln Operating Manual.
2. Technical specifications/vent system.

IMPORTANT

When ordering element holder or element wire replacement, always supply the following information:

- (1) Kiln Model Number
- (2) Serial Number
- (3) Voltage
- (4) Phase

ELEMENTS AVAILABLE FOR DISCONTINUED GOLD AND SILVER KILNS

AMACO® SILVER KILNS

| Kiln No. | Code No. | Part Description | No. Per Kiln | Price Each |
|----------|----------|-------------------------|--------------|------------|
| AS-1809 | 29864P | Element Coil, 208 Volts | 4 | \$42.00 |
| AS-1809 | 29865R | Element Coil, 240 Volts | 4 | \$42.00 |
| AS-1813 | 29866S | Element Coil, 208 Volts | 6 | \$48.00 |
| AS-1813 | 29867T | Element Coil, 240 Volts | 6 | \$48.00 |
| AS-1822 | 27841L | Element Coil, 208 Volts | 8 | \$42.00 |
| AS-1822 | 27840K | Element Coil, 240 Volts | 8 | \$42.00 |
| AS-2427 | 27843N | Element Coil, 208 Volts | 12 | \$48.00 |
| AS-2427 | 27842M | Element Coil, 240 Volts | 12 | \$48.00 |
| AS-2929 | 27846S | Element Coil, 240 Volts | 12 | \$68.00 |

SSU=1

AMACO® GOLD STANDARD™ KILNS

| Kiln No. | Code No. | Part Description | No. Per Kiln | Price Each |
|------------|----------|-------------------------|--------------|------------|
| CP-1024 | 29961B | Element Coil, 120 Volts | 3 | \$48.00 |
| FC-766 | 29963D | Element Coil, 120 Volts | 3 | \$48.00 |
| JS-26/P-4 | 28605X | Element Coil, 208 Volts | 6 | \$54.00 |
| JS-26/P-4 | 28599B | Element Coil, 240 Volts | 6 | \$54.00 |
| JS-39/P-6 | 28605X | Element Coil, 208 Volts | 9 | \$54.00 |
| JS-39/P-6 | 28599B | Element Coil, 240 Volts | 9 | \$54.00 |
| JS-43/P-8 | 28643N | Element Coil, 240 Volts | 6 | \$57.00 |
| JS-65/P-10 | 28643N | Element Coil, 240 Volts | 9 | \$57.00 |
| RK-4 | 29962C | Element Coil, 120 Volts | 3 | \$57.00 |
| TK-566 | 29960A | Element Coil, 120 Volts | 3 | \$48.00 |

SSU=1



KILNS



KILNS

AMACO® KILN ELEMENTS AND HOLDERS

AMACO® TOP LOADING KILNS

| Kiln No. | Code No. | Part Description | No. Per Kiln | Price Each |
|----------|----------|---------------------------------------|--------------|------------|
| HF-65 | 29476S | Element Coil, 208 Volts | 4 | \$37.00 |
| HF-65 | 29478E | Element Coil, 240 Volts | 4 | \$37.00 |
| HF-66 | 29499S | Element Coil, 120 Volts | 4 | \$48.00 |
| HF-75 | 29545A | Element Coil, 208 Volts | 6 | \$37.00 |
| HF-75 | 29547E | Element Coil, 240 Volts | 6 | \$37.00 |
| HF-76 | 29588P | Element Coil, 208 Volts | 6 | \$54.00 |
| HF-76 | 29590R | Element Coil, 240 Volts | 6 | \$54.00 |
| HF-85 | 29616E | Element Coil, 208 Volts | 6 | \$54.00 |
| HF-85 | 29618W | Element Coil, 240 Volts | 6 | \$54.00 |
| HF-86 | 29621A | Element Coil, 208 Volts | 6 | \$54.00 |
| HF-86 | 29623C | Element Coil, 240 Volts | 6 | \$54.00 |
| HF-87 | 29682R | Element Coil, 208 Volts | 6 | \$57.00 |
| HF-87 | 29684T | Element Coil, 240 Volts | 6 | \$57.00 |
| HF-95 | 29716D | Element Coil, 208 Volts | 4 | \$57.00 |
| HF-95 | 29718F | Element Coil, 240 Volts | 4 | \$57.00 |
| HF-96 | 29722K | Element Coil, 208 Volts | 6 | \$57.00 |
| HF-96 | 29724M | Element Coil, 240 Volts | 6 | \$57.00 |
| HF-97 | 29775B | Element Coil, 208 Volts | 6 | \$61.00 |
| HF-97 | 29777E | Element Coil, 240 Volts | 6 | \$61.00 |
| HF-101 | 29775B | Element Coil, 208 Volts | 9 | \$61.00 |
| HF-101 | 29777E | Element Coil, 240 Volts | 9 | \$61.00 |
| HF-105 | 29837K | Element Coil, 240 Volts, Single Phase | 6 | \$64.00 |
| HF-105 | 29836J | Element Coil, 240 Volts, Three Phase | 6 | \$64.00 |
| EC-15 | 29052G | Element Coil, 120 Volts | 4 | \$37.00 |
| EC-25 | 29102L | Element Coil, 120 Volts | 2 | \$42.00 |
| EC-26 | 29152B | Element Coil, 120 Volts | 2 | \$57.00 |
| EC-35 | 29198B | Element Coil, 120 Volts | 2 | \$42.00 |
| EC-45 | 29243P | Element Coil, 208 Volts | 3 | \$48.00 |
| EC-45 | 29244B | Element Coil, 240 Volts | 3 | \$48.00 |
| EC-55 | 29295H | Element Coil, 208 Volts | 3 | \$48.00 |
| EC-55 | 29296W | Element Coil, 240 Volts | 3 | \$48.00 |

SSU=1

AMACO® FINE-ART KILN SERIES

| Kiln No. | Code No. | Part Description | No. Per Kiln | Price Each |
|----------|----------|--|--------------|------------|
| FA-44 | 29365W | Bottom Element Coil, 208 Volts, Set of 2 wires | 1 | \$90.00 |
| FA-44 | 29367Y | Bottom Element Coil, 240 Volts, Set of 2 wires | 1 | \$97.00 |
| FA-44 | 29380N | Side Element Coil, 208 Volts | 4 | \$64.00 |
| FA-44 | 29382B | Side Element Coil, 240 Volts | 4 | \$64.00 |
| FA-88 | 29438B | Bottom Element Coil, 208 Volts | 2 | \$73.00 |
| FA-88 | 29440D | Bottom Element Coil, 240 Volts | 2 | \$77.00 |
| FA-88 | 29452R | Side Element Coil, 208 Volts | 4 | \$57.00 |
| FA-88 | 29454T | Side Element Coil, 240 Volts | 4 | \$57.00 |

SSU=1

ELEMENTS AVAILABLE FOR DISCONTINUED CRUSADER KILNS

CRUSADER ELECTRIC KILNS

| Kiln No. | Code No. | Part Description | No. Per Kiln | Price Each |
|------------------|----------|-------------------------|--------------|------------|
| 215 | 27841L | Element Coil, 208 Volts | 6 | \$42.00 |
| 215 | 27840K | Element Coil, 240 Volts | 6 | \$42.00 |
| 220 | 27845R | Element Coil, 208 Volts | 8 | \$42.00 |
| 220 | 27844P | Element Coil, 240 Volts | 8 | \$42.00 |
| 222 | 27843N | Element Coil, 208 Volts | 8 | \$48.00 |
| 222 | 27842M | Element Coil, 240 Volts | 8 | \$48.00 |
| 224 | 27843N | Element Coil, 208 Volts | 10 | \$48.00 |
| 224 | 27842M | Element Coil, 240 Volts | 10 | \$48.00 |
| 224 ('A' series) | 27799A | Element Coil, 208 Volts | 10 | \$48.00 |
| 227 | 27841L | Element Coil, 208 Volts | 8 | \$42.00 |
| 227 | 27840K | Element Coil, 240 Volts | 8 | \$42.00 |
| 270 | 27898E | Element Coil, 208 Volts | 12 | \$48.00 |
| 270 | 27897D | Element Coil, 240 Volts | 12 | \$48.00 |
| 274 | 27843N | Element Coil, 208 Volts | 12 | \$48.00 |
| 274 | 27842M | Element Coil, 240 Volts | 12 | \$48.00 |
| 294/299 | 27847T | Element Coil, 208 Volts | 12 | \$68.00 |
| 294/299 | 27846S | Element Coil, 240 Volts | 12 | \$68.00 |

SSU=1

Element Wire Pins For All AMACO® Kilns

32325D Kanthal A-1 Wire Pins, per dozen\$35.00

AMACO KILN ELEMENTS AND HOLDERS

AMACO® FRONT LOADING KILNS

| Kiln No. | Code No. | Part Description | No. Per Kiln | Price Each |
|----------|----------|--|--------------|------------|
| AH-4 | 28049E | Bottom Element Coil, 208 Volts, Set of 2 wires | 1 | \$90.00 |
| AH-4 | 28051G | Bottom Element Coil, 240 Volts, Set of 2 wires | 1 | \$90.00 |
| AH-4 | 28055L | Side Element Coil, 208 Volts | 4 | \$64.00 |
| AH-4 | 28057N | Side Element Coil, 240 Volts | 4 | \$64.00 |
| AH-6 | 28122M | Bottom Element Coil, 208 Volts | 2 | \$42.00 |
| AH-6 | 28124P | Bottom Element Coil, 240 Volts | 2 | \$42.00 |
| AH-6 | 28134B | Side Element Coil, 208 Volts | 4 | \$64.00 |
| AH-6 | 28136D | Side Element Coil, 240 Volts | 4 | \$64.00 |
| AH-8 | 28202D | Bottom Element Coil, 208 Volts | 3 | \$64.00 |
| AH-8 | 28204F | Bottom Element Coil, 240 Volts | 3 | \$64.00 |
| AH-8 | 28208K | Side Element Coil, 208 Volts | 6 | \$64.00 |
| AH-8 | 28210M | Side Element Coil, 240 Volts | 6 | \$64.00 |
| AH-10 | 28275L | Bottom Element Coil, 208 Volts | 4 | \$64.00 |
| AH-10 | 28277N | Bottom Element Coil, 240 Volts | 4 | \$64.00 |
| AH-10 | 28281T | Side Element Coil, 208 Volts | 8 | \$61.00 |
| AH-10 | 28283H | Side Element Coil, 240 Volts | 8 | \$61.00 |
| AH-25 | 28644M | Element Coil, 208 Volts, Single Phase | 12 | \$61.00 |
| AH-25 | 28647S | Element Coil, 208 Volts, Three Phase | 12 | \$61.00 |
| AH-25 | 28645P | Element Coil, 240 Volts, Single Phase | 12 | \$61.00 |
| AH-25 | 28648T | Element Coil, 240 Volts, Three Phase | 12 | \$61.00 |

SSU=1

AMACO® METAL ENAMELING KILNS

| Kiln No. | Code No. | Part Description | No. Per Kiln | Price Each |
|----------|----------|---|--------------|------------|
| 62-E | 28918L | Element Coil, 120 Volts | 2 | \$37.00 |
| 62-EFC | 28911D | Element Coil, 120 Volts | 2 | \$37.00 |
| 64-E | 28956C | Element Coil, 120 Volts, Set of 2 wires | 1 | \$64.00 |
| 67-E | 28994T | Element Coil, 120 Volts | 2 | \$37.00 |
| 67-EFC | 28987L | Element Coil, 120 Volts | 2 | \$37.00 |
| FA-20 | 22242G | Element Coil, 240 Volts | 4 | \$48.00 |
| MK-4 | 28902T | Element Coil, 120 Volts | 1 | \$37.00 |

SSU=1

IMPORTANT

When ordering element holder or element wire replacement, always supply the following information:

- (1) Kiln Model Number
- (2) Serial Number
- (3) Voltage
- (4) Phase







KILNS



KILNS

EXCEL[®] KILN COMPARISON CHART

| Kiln Model Photos are shown to scale for size comparison | Maximum Recommended Temperature | Firing Chamber Area | Chamber Size | Exterior Dimensons | Kiln Weight | Shipping Weight (approximate) | Kiln Vent |
|--|---------------------------------------|--|---|--|-----------------------|----------------------------------|--|
| EX-232SF  8-sided | Cone 10 2381°F 1305°C | 3.2 cubic feet 0.09 cubic meters | 17½" diameter 22" deep 44.45cm diameter 55.88cm deep | 29" w 22½" d 36" h 73.66cm w 57.15cm d 91.44cm h | 155 lbs. 69.75 Kg | 165 lbs. 74.84 Kg | Master KilnVent 29968J 110V \$826.00 29983D 240V \$1,207.00 |
| EX-329SF  8-sided | Cone 10 2381°F 1305°C | 2.9 cubic feet 0.08 cubic meters | 16½" diameter 22" deep 41.91cm diameter 55.88cm deep | 29" w 22½" d 36" h 73.66cm w 57.15cm d 91.44cm h | 170 lbs 76.5 Kg | 180 lbs. 81.65 Kg | Master KilnVent 29968J 110V \$826.00 29983D 240V \$1,207.00 |
| EX-257SF  10-sided | Cone 10 2381°F 1305°C | 5.7 cubic feet 0.16 cubic meters | 23½" diameter 22" deep 59.69cm diameter 55.88cm deep | 35" w 28½" d 36" h* 88.9cm w 72.39cm d 91.44cm h* | 265 lbs. 119.25 Kg | 290 lbs.** 131.542 Kg** | Master KilnVent 29968J 110V \$826.00 29983D 240V \$1,207.00 |
| EX-353SF  10-sided | Cone 10 2381°F 1305°C | 5.25 cubic feet 0.15 cubic meters | 22½" diameter 22" deep 57.15cm diameter 55.88cm deep | 35" w 28½" d 36" h* 88.9cm w 72.39cm d 91.44cm h* | 295 lbs. 132.75 Kg | 320 lbs.** 145.15 Kg** | Master KilnVent 29968J 110V \$826.00 29983D 240V \$1,207.00 |

EXCEL® KILN COMPARISON CHART

| Kilowatt Rating | Electrical Requirements | Supplied Power Cord | Amperage Rating | Kiln with Select Fire™ and Standard Hinge Single Phase | Kiln with Select Fire™ and Standard Hinge Three Phase | Kiln with Select Fire™ and EZ-Lift Single Phase | Kiln with Select Fire™ and EZ-Lift Three Phase | Kiln Model |
|------------------------------|---|--|---|--|--|--|--|------------|
| 8 | 8 Gauge Wire | 50 AMP Cord with NEMA 6-50 Plug | 38.5 @ 208 Volt 33.4 @ 240 Volt | 208V 25154S \$3,800.00 240V 25153N \$3,800.00 | Available in Single Phase Only | Available with Standard Hinge Only | Available in Single Phase with Standard Hinge Only | EX-232SF |
| 8 | 8 Gauge Wire | 50 AMP Cord with NEMA 6-50 Plug | 38.5 @ 208 Volt 33.4 @ 240 Volt | 208V 25156R \$4,350.00 240V 25155P \$4,350.00 | Available in Single Phase Only | Available with Standard Hinge Only | Available in Single Phase with Standard Hinge Only | EX-329SF |
| 10 (208V) 11.5 (240V) | Single Phase 6 Gauge Wire Three Phase 8 Gauge Wire | 50 AMP Cord Single Phase NEMA 6-50 Plug Three Phase NEMA-15-50 Plug | Single Phase 48 @ 208 Volt 48 @ 240 Volt Three Phase 34.6 @ 208 Volt 34.6 @ 240 Volt | Available with EZ-Lift Only | Available with EZ-Lift Only | 208V 25158W \$4,850.00 240V 25157V \$4,850.00 | 208V 25160T \$4,850.00 240V 25159X \$4,850.00 | EX-257SF |
| 10 (208V) 11.5 (240V) | Single Phase 6 Gauge Wire Three Phase 8 Gauge Wire | 50 AMP Cord Single Phase NEMA 6-50 Plug Three Phase NEMA-15-50 Plug) | Single Phase 48 @ 208 Volt 48 @ 240 Volt Three Phase 34.6 @ 208 Volt 34.6 @ 240 Volt | Available with EZ-Lift Only | Available with EZ-Lift Only | 208V 25162B \$5,150.00 240V 25161A \$5,150.00 | 208V 25164D \$5,150.00 240V 25163C \$5,150.00 | EX-353SF |





KILNS



KILNS

EXCEL[®] KILN COMPARISON CHART

| Kiln Model Photos are shown to scale for size comparison | Maximum Recommended Temperature | Firing Chamber Area | Chamber Size | Exterior Dimensons | Kiln Weight | Shipping Weight (approximate) | Kiln Vent |
|--|---|---|---|---|-------------------------------|-----------------------------------|--|
| <p>EX-381SF</p>  <p>12-sided</p> | <p>Cone 10 2381°F 1305°C (240V Single or Three Phase, 208V Three Phase)</p> <hr/> <p>Cone 8 2320°F 1271°C (208V Single Phase)</p> | <p>8.1 cubic feet</p> <p>0.23 cubic meters</p> | <p>28" diameter 22" deep</p> <p>71.1cm diameter 55.88cm deep</p> | <p>40 1/2" w 34" d 36" h*</p> <p>102.9cm w 86.4cm d 91.44cm h*</p> | <p>335 lbs. 150.75 Kg</p> | <p>365 lbs.** 164.25 Kg**</p> | <p>Master KilnVent 29968J 110V \$826.00 29983D 240V \$1,207.00</p> |
| <p>EX-270SF</p>  <p>10-sided</p> | <p>Cone 10 2381°F 1305°C (240V Single or Three Phase, 208V Three Phase)</p> <hr/> <p>Cone 6 2269°F 1243°C (208V Single Phase)</p> | <p>7.0 cubic feet</p> <p>0.21 cubic meters</p> | <p>23 3/8" diameter 27" deep</p> <p>59.37cm diameter 68.58cm deep</p> | <p>35" w 31" d 42 3/4" h*</p> <p>88.9cm w 78.74cm d 108.59cm h*</p> | <p>187 lbs. 84.82 Kg</p> | <p>290 lbs.** 131.54 Kg**</p> | <p>Master KilnVent 29968J 110V \$826.00 29983D 240V \$1,207.00</p> |
| <p>EX-365SF</p>  <p>10-sided</p> | <p>Cone 10 2381°F 1305°C</p> | <p>6.57 cubic feet</p> <p>0.20 cubic meters</p> | <p>22 3/8" diameter 27" deep</p> <p>56.83cm diameter 68.58cm deep</p> | <p>35" w 31" d 42 3/4" h*</p> <p>88.9cm w 78.74cm d 108.59cm h*</p> | <p>215 lbs. 97.52 Kg</p> | <p>320 lbs.** 145.15 Kg**</p> | <p>Master KilnVent 29968J 110V \$826.00 29983D 240V \$1,207.00</p> |

EXCEL® KILN COMPARISON CHART





KILNS

| Kilowatt Rating | Electrical Requirements | Supplied Power Cord | Amperage Rating | Kiln with Select Fire™ and Standard Hinge Single Phase | Kiln with Select Fire™ and Standard Hinge Three Phase | Kiln with Select Fire™ and EZ-Lift Single Phase | Kiln with Select Fire™ and EZ-Lift Three Phase | Kiln Model |
|---|------------------------------|---|--|---|--|--|---|---|
| Single Phase 10 (208V) 11.5 (240V) | Single Phase 6 Gauge Wire | 50 AMP Cord Single Phase NEMA 6-50 Plug | Single Phase 48 @ 208 Volt 48 @ 240 Volt | Available with EZ-Lift Only | Available with EZ-Lift Only | 208V 25166F \$5,650.00 | 208V 25168L \$5,650.00 | EX-381SF |
| Three Phase 11.5 (208V) 11.5 (240V) | Three Phase 8 Gauge Wire | Three Phase NEMA-15-50 Plug | Three Phase 40 @ 208 Volt 34.6 @ 240 Volt | | | 240V 25165E \$5,650.00 | 240V 25167G \$5,650.00 | |
| Single Phase 10 (208V) 11.5 (240V) | Single Phase 6 Gauge Wire | 50 AMP Cord Single Phase NEMA 6-50 Plug | Single Phase 48.0 @ 208 Volt 48.0 @ 240 Volt | Available with EZ-Lift Only | Available with EZ-Lift Only | 208V 25105E \$5,600.00 | 208V 25107G \$5,600.00 | EX-270SF |
| Three Phase 11 (208V) 11.5 (240V) | Three Phase 8 Gauge Wire | Three Phase NEMA-15-50 Plug | Three Phase 31.7 @ 208 Volt 29.3 @ 240 Volt | | | 240V 25106F \$5,600.00 | 240V 25108J \$5,600.00 | |
| Retrofit kits are available for these models purchased without EZ-Lift. See page 57. | | | | | | | | |
| Single Phase 10 (208V) 11.5 (240V) | Single Phase 6 Gauge Wire | 50 AMP Cord Single Phase NEMA 6-50 Plug | Single Phase 48.0 @ 208 Volt 48.0 @ 240 Volt | Available with EZ-Lift Only | Available with EZ-Lift Only | 208V 25113N \$5,400.00 | 208V 25115R \$5,400.00 | EX-365SF Zone Control Select Fire™ (24133G) is an available option for \$577.00. See page 60 or call AMACO® for more information. |
| Three Phase 11 (208V) 11.5 (240V) | Three Phase 8 Gauge Wire | Three Phase NEMA-15-50 Plug | Three Phase 31.7 @ 208 Volt 29.3 @ 240 Volt | | | 240V 25114P \$5,400.00 | 240V 25116T \$5,400.00 | |
| Retrofit kits are available for these models purchased without EZ-Lift. See page 57. | | | | | | | | |



KILNS

EXCEL[®] KILN COMPARISON CHART

| Kiln Model Photos are shown to scale for size comparison | Maximum Recommended Temperature | Firing Chamber Area | Chamber Size | Exterior Dimensions | Kiln Weight | Shipping Weight (approximate) | Kiln Vent |
|---|--|---|---|--|-------------------------------|-----------------------------------|--|
| <p>EX-399SF</p>  <p>12-sided</p> | <p>Cone 8 2320°F 1271°C (240V Single or Three Phase, 208V Three Phase)</p> <hr/> <p>Cone 5 2205°F 1207°C (208V Single Phase)</p> | <p>9.92 cubic feet</p> <p>0.30 cubic meters</p> | <p>28" diameter 27" deep</p> <p>71.12cm diameter 68.58cm deep</p> | <p>38" w 33" d 43" h*</p> <p>96.52cm w 83.82cm d 109.22cm h*</p> | <p>290 lbs. 131.54 Kg</p> | <p>400 lbs.** 181.44 Kg**</p> | <p>Master KilnVent 29968J 110V \$826.00 29983D 240V \$1,207.00</p> |
| <p>EX-1099SF</p>  <p>12-sided</p> | <p>Cone 10 2381°F 1305°C</p> | <p>9.92 cubic feet</p> <p>0.30 cubic meters</p> | <p>28" diameter 27" deep</p> <p>71.12cm diameter 68.58cm deep</p> | <p>38" w 33" d 43" h*</p> <p>96.52cm w 83.82cm d 109.22cm h*</p> | <p>290 lbs. 131.54 Kg</p> | <p>410 lbs.** 185.97 Kg**</p> | <p>Master KilnVent 29968J 110V \$826.00 29983D 240V \$1,207.00</p> |
| <p>EX-1266SF</p>  <p>12-sided</p> | <p>Cone 10 2381°F 1305°C</p> | <p>6.6 cubic feet</p> <p>0.20 cubic meters</p> | <p>28" diameter 18" deep</p> <p>71.12cm diameter 45.72cm deep</p> | <p>38" w 33" d 34" h*</p> <p>96.52cm w 83.82cm d 86.36cm h*</p> | <p>230 lbs. 104.33 Kg</p> | <p>355 lbs.** 161.03 Kg**</p> | <p>Master KilnVent 29968J 110V \$826.00 29983D 240V \$1,207.00</p> |

NOTE: WIDTH DIMENSION INCLUDES CONTROL BOX AND HEIGHT INCLUDES THE STAND (8", 203MM) ON ALL "EX" KILNS. *HEIGHT WITH EZ-LIFT. **WEIGHT WITH EZ-LIFT.

▲ Cone number specifies maximum temperature for shelves

EXCEL® KILN COMPARISON CHART

| Kilowatt Rating | Electrical Requirements | Supplied Power Cord | Amperage Rating | Kiln with Select Fire™ and Standard Hinge Single Phase | Kiln with Select Fire™ and Standard Hinge Three Phase | Kiln with Select Fire™ and EZ-Lift Single Phase | Kiln with Select Fire™ and EZ-Lift Three Phase | Kiln Model |
|---|---|---|---|---|--|--|--|--|
| Single Phase 10 (208V) 11.5 (240V) Three Phase 11 (208V) 11.5 (240V) | Single Phase 6 Gauge Wire Three Phase 8 Gauge Wire | 50 AMP Cord Single Phase NEMA 6-50 Plug Three Phase NEMA-15-50 Plug | Single Phase 48.0 @ 208 Volt 48.0 @ 240 Volt Three Phase 31.7 @ 208 Volt 29.3 @ 240 Volt | Available with EZ-Lift Only | Available with EZ-Lift Only | 208V 25137V \$6,000.00 240V 25138W \$6,000.00 | 208V 25139S \$6,000.00 240V 25140B \$6,000.00 | EX-399SF |
| | | | | | | Retrofit kits are available for these models purchased without EZ-Lift. See page 59. | | |
| 14 | Single Phase 3 Gauge Wire (208V) 4 Gauge Wire (240V) Three Phase 6 Gauge Wire (208V) 8 Gauge Wire (240V) | Direct Wire | Single Phase 69.0 @ 208 Volt 60.0 @ 240 Volt Three Phase 46.7 @ 208 Volt 40.0 @ 240 Volt | Available with EZ-Lift Only | Available with EZ-Lift Only | 208V 25141X \$6,950.00 240V 25142A \$6,950.00 | 208V 25143C \$6,950.00 240V 25144D \$6,950.00 | EX-1099SF Zone Control Select Fire™ (24133G) is an available option for \$577.00. See page 60 or call AMACO® for more information. |
| | | | | | | Retrofit kits are available for these models purchased without EZ-Lift. See page 59. | | |
| 10 (208V) 11.5 (240V) | Single Phase 6 Gauge Wire | 50 AMP Cord with NEMA 6-50 Plug | Single Phase 48.0 @ 208 Volt 48.0 @ 240 Volt | Available with EZ-Lift Only | Available with EZ-Lift Only | 208V 25145E \$5,450.00 240V 25146F \$5,450.00 | Available in Single Phase Only | EX-1266SF |
| | | | | | | Retrofit kits are available for these models purchased without EZ-Lift. See page 55. | | |



KILNS

CLAY MODELING TOOLS



POTTERY TOOL KIT

Set of eight tools includes: wood potter's rib, synthetic sponge, loop tool, ribbon tool, needle tool, wood modeling tool, wire clay cutter, and steel scraper.

11035M Pottery Tool Kit: set of eight tools **\$25.20**
SSU=12



MODELING CLAY TOOLS

Basic, economical, hard maple tools are perfect for modeling and sculpting in soft clays.

11108R A-B-C Set, (4 each A, B, C) **\$15.80**
11103L A-1 only, (1) dozen (Flat Ends) **\$15.20**
11104M B-2 only, (1) dozen (Tapered Ends) **\$15.20**
11105N C-3 only, (1) dozen (Tapered/Angled Ends) **\$15.50**

SSU=1 dozen, Shipping Weight 1/3 lb.

Shipping weights are approximate.



HARDWOOD PONY ROLLER

Dual rollers (1 5/8" dia.) held together by chrome steel frame. Flatten or smooth clay, or impress a texture plate into clay. 4" and 2" wide rollers.

11198T Hardwood Pony Roller **\$23.00**
SSU=1



LID MASTER

Size lids for pots and bowls. Standard sizes lids up to 1 1/2".

33051F Standard Lid Master **\$32.60**
SSU=1, Shipping Weight 3 oz.



CLAY TRIMMING TOOLS



ADJUSTABLE CLAY SLICER

Heavy-duty stainless steel wire cuts up to 7" wide. Perfect for cutting slabs and tiles. Bar adjusts to cut clay from 3/8" to 3 1/8" thick in 1/4" increments.

- 11070A** Adjustable Clay Slicer **\$20.50**
- 27702B** Replacement Wire..... **\$6.90**

SSU=1

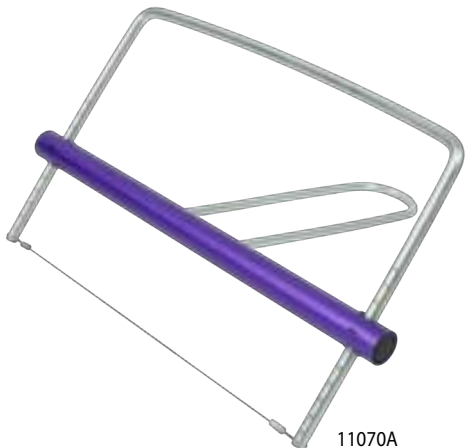

11070A



Tile cutting sleeve also fits our 4" wide Textured Clay Roller handle (11238V).

16010L

4-INCH CLAY TILE CUTTER

Easily create tiles or strips from slabs of clay without measuring! This 4-inch cutter does the measuring for you.

Cutting Sleeve Depth: 5/8"
Maximum Slab Thickness: 1/2"
Cut Width: 4"

- 16012N** Sleeve **ONLY** **\$6.75**
SSU=1, Shipping Weight 6 oz.
- 16010L** Sleeve **WITH** Handle..... **\$13.40**
SSU=6, Shipping Weight 14 oz.

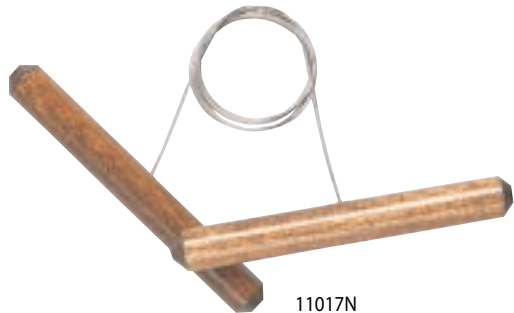

11017N

Using the Clay Tile Cutter

- Roll out slab of clay no thicker than 1/2".
- To keep clay from sticking to the clay tile cutter, either 1) spray cutter lightly with non-stick cooking oil spray or 2) lay thin plastic wrap on top of clay slab before cutting (this method also creates nice rounded edges).

WIRE CLAY CUTTER

Slice lump clay or cut pottery from wheel head. Hardwood handles with about 18" of stainless steel cutting wire.

- 11017N** Wire Clay Cutter..... **\$5.00**

SSU=1



TEXTURED CLAY ROLLERS



VINE/LEAF (4" wide)

11234D Texture Roller S
 Sleeve **ONLY**, Vine/Leaf**\$7.60**
 SSU=1, Shipping Weight 6 oz.

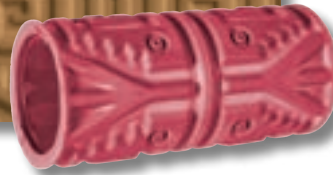

PRE-COLUMBIAN (4" wide)

11225X Texture Roller
 Sleeve **ONLY**, Pre-Columbian**\$7.60**
 SSU=1, Shipping Weight 6 oz.



BAMBOO (4" wide)

11370V Texture Roller
 Sleeve **ONLY**, Bamboo**\$7.60**
 SSU=1, Shipping Weight 6 oz.



TRIBAL (4" wide)

11235E Texture Roller
 Sleeve **ONLY**, Tribal**\$7.60**
 SSU=1, Shipping Weight 6 oz.



KOI FISH (4" wide)

11236F Texture Roller
 Sleeve **ONLY**, Koi Fish**\$7.60**
 SSU=1, Shipping Weight 6 oz.

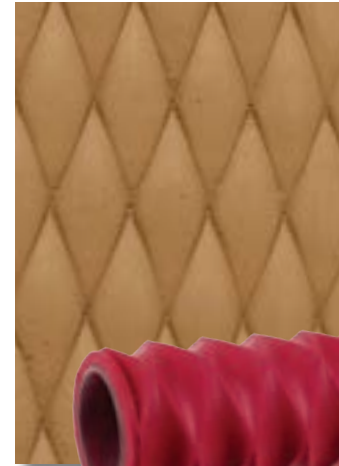

DIAMOND (4" wide)

11382X Texture Roller
 Sleeve **ONLY**, Diamond**\$7.60**
 SSU=1, Shipping Weight 6 oz.

TEXTURED CLAY ROLLERS



CHAIN LINK (2 1/2" wide)

11365B Texture Roller Sleeve **ONLY**, Chain Link..... **\$7.05**
SSU=1, Shipping Weight 6 oz.



PRE-COLUMBIAN (2 1/2" wide)

11362V Texture Roller Sleeve **ONLY**, Pre-Columbian..... **\$7.05**
SSU=1, Shipping Weight 6 oz.



CIRCULAR (2 1/2" wide)

11363W Texture Roller Sleeve **ONLY**, Circular..... **\$7.05**
SSU=1, Shipping Weight 6 oz.



WAVE DOTS (2 1/2" wide)

11364A Texture Roller Sleeve **ONLY**, Wave Dots..... **\$7.05**
SSU=1, Shipping Weight 6 oz.



16008G

16005F

CLASS PACKS

FOUR Sleeves, FOUR Handles

16005F 4" wide Textured Clay Roller Class Pack, includes **FOUR** sleeves (Koi Fish, Pre-Columbian, Tribal and Vine/Leaf) and **FOUR** handles **\$55.80**

16008G 2 1/2" wide Textured Clay Roller Class Pack, includes **FOUR** sleeves (Chain Link, Circular, Pre-Columbian and Wave Dots) and **FOUR** handles **\$53.20**
SSU=1, Shipping Weight 2.9 lbs.

FOUR Sleeves, ONE Handle

16006E 4" wide Textured Clay Roller Class Pack, includes **FOUR** sleeves (Koi Fish, Pre-Columbian, Tribal and Vine/Leaf) and **ONE** handle **\$36.75**

16007H 2 1/2" wide Textured Clay Roller Class Pack, includes **FOUR** sleeves (Chain Link, Circular, Pre-Columbian and Wave Dots) and **ONE** handle **\$34.45**
SSU=1, Shipping Weight 2 lbs.

SIX Sleeves, SIX Handles

16016V 4" wide Textured Clay Roller Class Pack, includes **SIX** sleeves (Bamboo, Diamond, Koi Fish, Pre-Columbian, Tribal and Vine/Leaf) and **SIX** handles **\$83.70**
SSU=1, Shipping Weight 3.5 lbs.



11366E

11238V

HANDLES

11238V 4" Texture Roller Handle **\$6.35**

11366E 2 1/2" Texture Roller Handle **\$6.25**
SSU=1, Shipping Weight 6 oz.





AMACO® CERAMIC TILES

Decorate Cone 04 (1971°F, 1077°C) bisque tiles with AMACO® low fire glazes and underglazes. Glaze fire to Cone 05 (1911°F, 1044°C).

- 11334M** 4 1/4" x 4 1/4" bisque.....**\$3.50**
SSU=72
- 11333L** 6" x 6" bisque.....**\$5.30**
SSU=48



AMACO® GLAZE CHIPS

Use Cone 04 (1971°F, 1077°C) bisque chips to test low-fire glazes before firing actual pieces. Glaze fire to Cone 05 (1911°F, 1044°C).

- 37587A** each**\$0.70** NET
SSU=1

DECORATING TOOLS AND BRUSHES



AMACO® DECORATING WHEEL NO. 700

Wheel No. 700 is made of plastic, inexpensive and well balanced for modeling, sculpting, banding, and decorating.

- 11079K** No. 700, 8" head.....**\$39.90**
SSU=12



HYDROMETER

Test the specific gravity of glazes and slip. Wet hydrometer and gently lower into liquid. 11"l.

- 11410C** Hydrometer.....**\$55.70**
SSU=1



11182B



11183R

FITCH FAN

Very soft hair, perfect for the application of glaze and underglaze.

- 11182B** Series 28, No. 4.....**\$15.30**
- 11183R** Series 28, No. 6.....**\$19.50**
SSU=6



DRYING/HEAT GUN

Use to dry clay which is too moist to work with or speed up the drying process of your art when time does not permit drying naturally. Also use to dry glaze coats so the next coat can be applied quicker.

A removable nozzle for wide or concentrated airflow is included. Temperature exceeds 400°F. 1000 watts. One Year Warranty.

- 86086L** Heat/Drying Gun.....**\$145.00**
SSU=1, Shipping Weight 1 1/2 lbs.

GLAZE DECORATING TOOLS



Ron Korczynski demonstrating Underglaze Applicator.

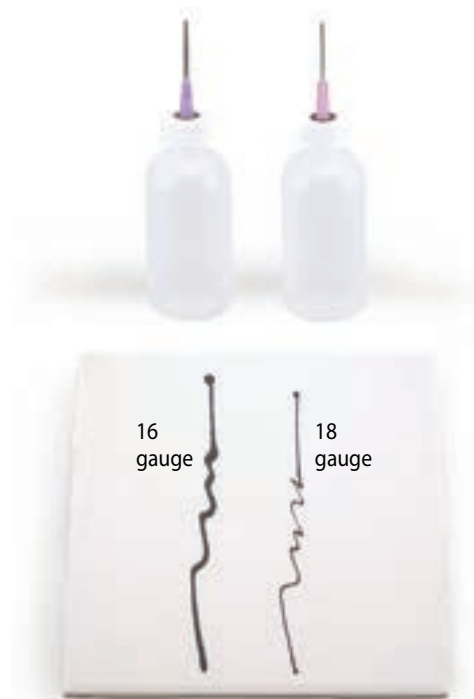

UNDERGLAZE APPLICATOR

Make medium or fine lines, dots and letters on ceramic pieces.

2 oz. Underglaze Applicator

- 11263K** 16 gauge\$8.40
- 11261G** 18 gauge\$8.40

SSU=12



SLIP TRAIL APPLICATOR

Syringe-type applicator allows excellent control when applying engobes or casting slips.

- 11446N** Applicator, each.....\$3.30

SSU=12

POLYMER CLAY TOOLS



POLYROLLER

8" non-stick acrylic roller conditions and rolls out smooth slabs of clay.

- 11058T** \$16.80

SSU=3, Shipping Weight 1 lb.



POLYBLADE

Slice polymer clay canes and blocks with long-lasting stainless steel blade. 6"l x 3/4"w.

- 11050H**\$9.20

SSU=6, Shipping Weight 3 oz.



ALL-PURPOSE SELF-HARDENING CLAYS



Conforms to
ASTM D-4236

MARBLEX™ SELF-HARDENING CLAY

Our premium quality gray self-hardening clay is formulated for handbuilding and sculpting techniques. Modeled objects are permanent without firing. Moist, ready-to-use. Pieces dry hard and durable, but not waterproof. Can be painted.

47336W X-25, Marblex, 5 lb. box.....**\$24.00**

SSU=6, Shipping Weight 33 lbs.

47340B X-25A, Marblex, 25 lb. carton.....**\$59.00**

SSU=1 each, Shipping Weight 27 lbs.



Conforms to
ASTM D-4236

MEXICAN POTTERY CLAY™

Our rich terra cotta premium quality self-hardening clay is formulated for handbuilding, sculpture and wheel throwing. Modeled objects resemble Native American or Mexican Pottery with little or no decoration necessary. Moist, ready-to-use. Pieces dry hard and durable, but not waterproof. Can be painted.

48652C X-119, Mexican Clay, 5 lb. box**\$24.00**

SSU=6, Shipping Weight 33 lbs.

48653D X-117, Mexican Clay, 25 lb. carton**\$59.00**

SSU=1 each, Shipping Weight 27 lbs.



Conforms to
ASTM D-4236

STONEX™ SELF-HARDENING CLAY

Our premium quality pale white self-hardening clay is formulated for handbuilding, wheel throwing and sculpture techniques. Knead Stonex™ to increase plasticity before modeling. Moist, ready-to-use. Pieces dry hard and durable, but not waterproof. Can be painted.

47338C X-35, Stonex, 5 lb. box**\$30.50**

SSU=6, Shipping Weight 33 lbs.

47339A X-325, Stonex, 25 lb. carton.....**\$82.00**

SSU=1 each, Shipping Weight 27 lbs.



ALL-PURPOSE AIR DRY CLAYS



Conforms to
ASTM D-4236



Conforms to
ASTM D-4236

AIR DRY MAGIC MUD® CLAY

This natural, reusable clay encourages unlimited discovery, sensory motor development, and self-expression. Our Multi-Project Pack was developed by a classroom teacher. Add water to air-dried objects to turn clay into a 'magic mud' again!

- 48661M** Magic Mud® Multi-Project Pack; 25 lbs. of clay,
8" wire clay cutter, 4-page guide.....**\$55.50**
SSU=1, Shipping Weight 27 lbs.
- 48664R** Magic Mud® Wire Clay Cutter, 8"..... **\$6.75**
SSU=1, Shipping Weight 1 oz.



AMACO® AIR DRY CLAYS

Buy our inexpensive all-purpose air dry clay to sculpt, hand model, or throw on a potter's wheel. Air dry your finished pieces slowly and evenly on all sides. Decorate with paint. Seal with shellac for strength and to waterproof. Or bisque fire to Cone 04 (1971°F, 1077°C) for hardness/permanency and to glaze.

- 10 lb. Carton**
- 46303C** Gray, 10 lb. carton.....**\$15.50**
- 46301A** Terra Cotta, 10 lb. carton**\$15.50**
- 46302B** White, 10 lb. carton**\$15.50**
SSU=2, Shipping Weight 22 lbs.
- 25 lb. Carton**
- 46317P** Gray, 25 lb. carton.....**\$31.00**
- 46319S** Terra Cotta, 25 lb. carton**\$31.00**
- 46318R** White, 25 lb. carton**\$31.00**
SSU=1, Shipping Weight 26 lbs.



NON-FIRING PRODUCTS

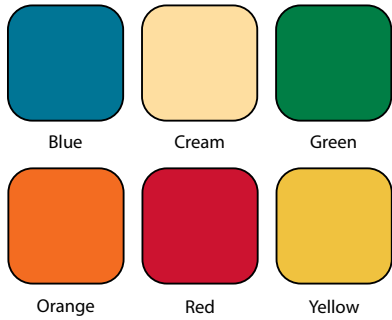

PLAST-I-CLAY® MODELING CLAY

Our economical non-hardening modeling clay helps children develop sensory motor skills and encourages self-expression. Available in bright colors that blend easily. Can be reused when stored airtight.

**25 lb. Bulk Single Color,
Individually Wrapped 1/4 lb. Sticks**

| | | |
|---------------|----------------------|-----------------|
| 91201A | No. 25K, Blue..... | \$192.00 |
| 91203C | No. 25K, Cream..... | \$192.00 |
| 91205E | No. 25K, Green..... | \$192.00 |
| 91206F | No. 25K, Orange..... | \$192.00 |
| 91207G | No. 25K, Red..... | \$192.00 |
| 91209K | No. 25K, Yellow..... | \$192.00 |

SSU=1, Shipping Weight 30 lbs.



MODELING CLAYS FOR ALL AGES

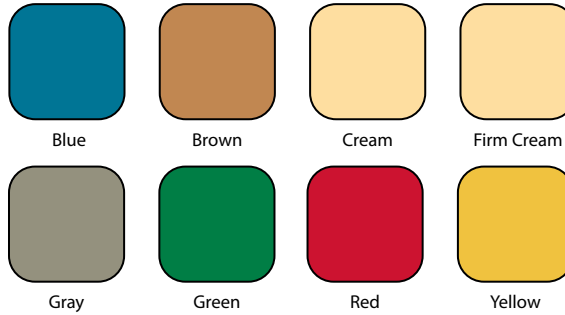

PERMOPLAST® AMERICA'S FIRST MODELING CLAY



Conforms to
ASTM D-4236

Develop small motor skills and hand/eye coordination with our classic non-hardening clay. Students and claymation filmmakers like Art Clokey have created original characters (Gumby and Pokey) for mixed media art projects with Permoplast®. Available in bright colors that blend easily.

Our Cream color is used for scale modeling and prototypes. Can be reused when stored airtight.



90091E

ASSORTMENTS



Brown, Gray,
Green, Red

X-34—4 Colors

| | | |
|---------------|--------------------------------|----------------|
| 90091E | X-34, 4 oz. of each color..... | \$10.00 |
|---------------|--------------------------------|----------------|

SSU=24, Shipping Weight 27 lbs.



Blue, Green,
Red, Yellow

X-36—4 Colors

| | | |
|---------------|--------------------------------|----------------|
| 90095Y | X-36, 4 oz. of each color..... | \$10.00 |
|---------------|--------------------------------|----------------|

SSU=24, Shipping Weight 27 lbs.

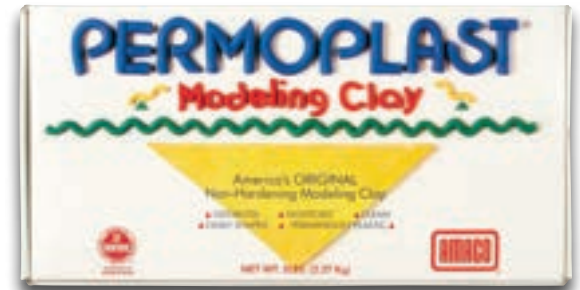

90078F

BULK SINGLE COLOR PACKS

5 lb. Bulk: 4-Stick, 1 lb. pkgs., Single Color

| | | |
|---------------|------------------|----------------|
| 90078F | X-30, Cream..... | \$43.00 |
| 90075C | X-30, Gray..... | \$43.00 |

SSU=10 Packages (one color), Shipping Weight 55 lbs.

45 lb. Bulk: Twelve 3.75 lb blocks, Single Color

| | | |
|---------------|------------------|-----------------|
| 90108N | X-28, Cream..... | \$313.00 |
| 90105K | X-28, Gray..... | \$313.00 |

SSU=1 each (one color), Shipping Weight 50 lbs.

50 lb. Bulk: 4-Stick, 1 lb. pkgs., Single Color

| | | |
|---------------|-----------------------|-----------------|
| 91228F | X-29, Cream..... | \$375.00 |
| 91225C | X-29, Firm Cream..... | \$375.00 |

SSU=1, Shipping Weight 53 lbs.



SINGLE COLOR PACKS

4-Stick 1 lb. Single Color Packs

| | | |
|---------------|-------------------|---------------|
| 90053D | X-33, Blue..... | \$9.50 |
| 90056G | X-33, Brown..... | \$9.50 |
| 90058J | X-33, Cream..... | \$9.50 |
| 90055F | X-33, Gray..... | \$9.50 |
| 90054E | X-33, Green..... | \$9.50 |
| 90051B | X-33, Red..... | \$9.50 |
| 90052C | X-33, Yellow..... | \$9.50 |

SSU=24, Shipping Weight 27 lbs.

SCULPTING, MOLD MAKING, & CASTING SUPPLIES



Conforms to
ASTM D-4236



SCULPTAMOLD® MODELING COMPOUND

Create masks, sculptures, floats, and stage backgrounds with this durable modeling material. Mix with water to form a paste that can be modeled or applied over armature. Sets in 30 minutes. Additions stick to form. Dries white. Carves, sands and paints easily.

- 41821C** SC-3, 3 lb. bag.....**\$13.75**
SSU=12, Shipping Weight 39 lbs.
- 41822D** SC-25, 25 lb. carton.....**\$85.50**
SSU=1, Shipping Weight 27 lbs.
- 41823E** SC-50, 50 lb. carton.....**\$157.00**
SSU=1, Shipping Weight 52 lbs.



Conforms to
ASTM D-4236



CLAYCRETE® INSTANT PAPIER MACHE

Create lightweight puppets, marionettes and stage props with this modeling material. Just mix with water to form a paste that can be modeled or applied over armature. Sets in 30 minutes. Additions stick to the form, but not to hands. Dries white. Can be painted when completely dry.

- 41810B** 1 lb. bag.....**\$15.00**
SSU=24, Shipping Weight 25 lbs.
- 41812S** 20 lb. carton.....**\$148.00**
SSU=1, Shipping Weight 22 lbs.



Conforms to
ASTM D-4236

POTTERY PLASTER

Large scale original molds for slip casting are best made with this highly absorbent, white pottery plaster. Holds fine detail.

- 52803P** Pottery Plaster, 50 lb. bag.....**\$42.00**
SSU=1, Shipping Weight 156 lbs.



Conforms to
ASTM D-4236

AMACO® RUBBER LATEX

The CL seal restricts this product from children under the age of 13.

Older users must follow all cautionary labeling.

Make castings quickly and accurately from molds made with rubber latex. Apply white liquid latex over original models. Completed molds will be tough, flexible, and withstand 200-300 castings. When dry, molds have a weight loss of 42%.

- 89915S** Rubber Latex, 1 Pint jar.....**\$46.00**
SSU=12, Shipping Weight 21 lbs.

NON-FIRING PRODUCTS



MULTI-MEDIA SUPPLIES FOR ART CENTERS AND STUDIO



AMACO® NAIL HOLE & CORNER FILLER

A pliable filler for cracks, crevices and nail holes. Especially useful for picture framing, but also works great on wood furniture. Will not dry out or shrink.



Conforms to ASTM D-4236



White



Ivory



Natural



Walnut



Silver



Gray



Black



Dark Walnut

The CL seal restricts this product from children under the age of 13. Older users must follow all cautionary labeling.



Conforms to ASTM D-4236



Gold



Dark Gold

Nail Hole & Corner Filler

| Color | 2 oz. Tins | | 1-lb. Plastic Jar | |
|-------------|------------|---------|-------------------|---------|
| | Cat. No. | Price | Cat. No. | Price |
| Black | 21418E | \$25.00 | 21468J | \$41.50 |
| Dark Walnut | 21424L | \$25.00 | | |
| Gray | 21426N | \$25.00 | | |
| Ivory | 21417D | \$25.00 | | |
| Natural | 21412X | \$25.00 | | |
| Silver | 21428B | \$25.00 | | |
| Walnut | 21411W | \$25.00 | 21461B | \$41.50 |
| White | 21419F | \$25.00 | 21469K | \$41.50 |

The CL seal restricts this product from children under the age of 13. Older users must follow all cautionary labeling.

| | | |
|-----------|--------|---------|
| Dark Gold | 21429C | \$27.50 |
| Gold | 21427P | \$27.50 |

SSU=12, 1 color
Shipping Weight 2¼ lbs.

SSU=1 each
Shipping Weight 1¼ lbs.



Conforms to ASTM D-4236



Conforms to ASTM D-4236

2 oz. tin comes with hang tag for easier merchandising. Hang on pegs or stack on shelves.

MULTI-MEDIA SUPPLIES FOR ART CENTERS AND STUDIOS



CANNOT BE SHIPPED BY AIR

RUB 'N BUFF® METALLIC FINISHES

The CL seal restricts this product from children under the age of 13. Older users must follow all cautionary labeling.

Formulated from carnauba waxes, fine metallic powders, and select pigments, for a finish no paint can duplicate. Rub onto clean, dry, or previously painted surface or on post-fired ceramics with a finger or soft cloth, then gently buff to a beautiful luster. More buff, more shine. **5 X more product than other brands!**



Teapot by Michael Kifer, Richland, Michigan, is decorated with AMACO® Velvet Underglazes, and fired before Rub 'n Buff® highlights are added on the spout, handle, and feet.



CANNOT BE SHIPPED BY AIR

INTERIOR BRUSH 'N LEAF® LIQUID METALLIC

The CL seal restricts this product from children under the age of 13. Older users must follow all cautionary labeling.

Liquid brush-on 'leafing' in one easy step for any surface, any material! Metallic flakes "leaf" into a solid, shiny metallic finish that dries quickly. Coverage is 7-8 sq. ft. on primed or unprimed surfaces.

- 76630K** Gold Leaf, 1 fl. oz.\$16.25
- 76631L** Antique Gold, 1 fl. oz.....\$16.25
- 76632M** Silver Leaf, 1 fl. oz.\$16.25

SSU=6, 1 color, Shipping Weight 1 1/2 lbs.

* **WARNING:** Interior Brush 'n Leaf can expose you to chemicals including Cumene, which are known to the State of California to cause cancer. For more information go to www.P65Warnings.ca.gov.



Conforms to ASTM D-4236

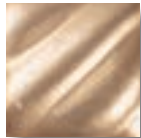

Gold Leaf



Antique Gold



Grecian Gold

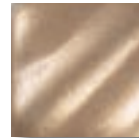

European Gold

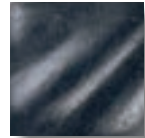

Ebony

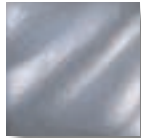

Pewter

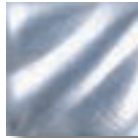

Silver Leaf

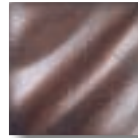

Spanish Copper

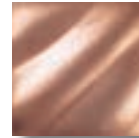

Autumn Gold

Rub 'n Buff Individual Colors, 1/2 fl. oz. tube (Gallons—Special Order)

| | Uncarded Cat. No. | Price | Carded Cat. No. | Price |
|---------------------|----------------------|--------|--------------------|--------|
| Antique Gold..... | 76303G | \$6.70 | 76362B | \$9.80 |
| Autumn Gold..... | 76304H | \$6.70 | 76372M | \$9.80 |
| Ebony..... | 76312S | \$6.70 | 76369J | \$9.80 |
| European Gold..... | 76310P | \$6.70 | 76379X | \$9.80 |
| Gold Leaf..... | 76302F | \$6.70 | 76361A | \$9.80 |
| Grecian Gold..... | 76301E | \$6.70 | 76371L | \$9.80 |
| Pewter..... | 76313T | \$6.70 | 76380A | \$9.80 |
| Silver Leaf..... | 76308M | \$6.70 | 76370K | \$9.80 |
| Spanish Copper..... | 76306K | \$6.70 | 76368H | \$9.80 |

SSU=12,
Shipping Weight 1 1/4 lbs.

SSU=6,
Shipping Weight 1 lb.



Conforms to ASTM D-4236

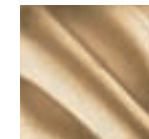

Antique Gold



Gold Leaf



Silver Leaf

NON-FIRING PRODUCTS

- A**
Adjustable Clay Slicer77
Air-Dry Clays83
Applicators.....36, 81
Art & Craft Materials.....82-87
Automatic Cut-Off Devices60-61
- B**
Bag, Plastic8
BatBrace.....46
Batmobile.....46
Bat Pins.....40
Bats: Plasti-Bat40
Bisque Fix8
Booties.....41
Brent Clay Extruder.....44
Brent Potter's Wheels37-39, 48-49
Brent Slab Rollers42-43
Brushes.....80
Brush 'n Leaf (Interior).....87
- C**
Caliper (Lid Master).....76
Canvas Covered Board40
Carts: Batmobile46
 Kiln Shelf46, 62
 SmartCart.....45
 Ware.....47
Cement, Kiln65
Ceramic Tiles36, 80
Chalk Crayons, Underglaze Decorating13
Choose Your Glaze23, 27
Classic Controller.....37-39
Clay Board (Canvas).....40
Claycrete.....85
Clay Cutter, Wire.....77
Clay Decorating Tools80-81
Clay Extruder.....44
Clay Extruder Dies.....45
Clay Extruder HD Mounts.....44
Clay Slicer, Adjustable.....77
Clay Texture Rollers.....78-79
Clay Tile Cutters77
Clay Trimming Tools77
Clays:
 Cutter (Tile)77
 Cutter (Wire)77
 Equipment.....37-47
 Firing.....5-7
 High Fire.....6-7
 Low Fire5
 Non-Firing and Modeling82-84
 Tools.....76-79
Comparison Charts
 Kilns.....70-75
 Wheels.....48-49
Cone 5 and 10 Underglaze
 Firing Charts.....9, 13
Crayons, Underglaze Decorating15
Cutters, Tile77
- D**
Decorating Colors:
 Underglaze Chalk Crayons15
 Liquid (LUG)12-13
 Pencils15
 Semi-Moist.....14
 Temperature/Color
 Variation Charts.....9, 13
 Velvets (V) [4 NEW COLORS]9-11
Decorating Tools.....80-81
Decorating Wheel80
Die Sets (Clay Extruder).....45
Dipping Glazes22, 26
Drying/Heat Gun80
- E**
Electric Kilns50-59, 70-75
Element Pins.....66, 68
Elements, Kiln66-69
EXCEL Kilns50-59, 70-75
Extruder, Clay.....44
Extruder Dies.....45
Extruder HD Mounts44
EZ-Lift (EXCEL Kilns).....52-59, 70-75
EZ-Lift Kits55, 57, 59
- F**
Fan Brushes80
Formulated Supplies8, 36, 65
- G**
Glaze Chips36, 80
Glazes:.....16-35
 Celadon (C) [5 NEW COLORS]24-25
 Cosmos (CO) [NEW]30-31
 Dipping Clear (DC)22
 Dipping & Layering (DL) [NEW]26
 Gloss (LG)16-17
 High Fire (HF).....34-35
 Matt (LM).....22
 Opalescent (O)20-21
 Potter's Choice (PC)28-29
 Potter's Choice Flux (PCF) [NEW].....30-31
 Satin Matte (SM) [6 NEW COLORS]32-33
 Shino (SH)32-33
 Teacher's Palette (TP).....18-19
 Teachers Palette Light (TPL)20-21
 Texturizers31, 34-35
Gloves, Kiln64
Gum Solution.....36
- H**
Heat Gun80
High Fire Clays.....6-7
High Fire Kilns.....50-59, 70-75
Hydrometer80
- K**
Kiln Cement.....65
Kiln Controls, Automatic.....60
Kiln Gloves64
Kiln Shelf Cart46, 62
Kiln Shelf Wash65
Kiln Shelves.....63
Kiln Sitters61
Wiring Kits61
- L**
Kilns, AMACO
 Elements (Replacement)68-69
 Shelves.....63
Kilns, EXCEL50-59, 70-75
 Comparison Chart70-75
 Elements (Replacement)66-67
 Shelves.....63
Kiln Vents.....62
Kits: Tool, Pottery.....76
- L**
Latex, Rubber8, 85
Leg Extension Kit, Brent Wheels41
Lid Master.....76
Low Fire Clays5
Low Fire Glazes16-23
- M**
Magic Mud83
Marblex.....82
Master KilnVent.....62
Metallic Finishes87
Mexican Pottery Clay82
Mid/High Fire Clays6-7
Mid/High Fire Glazes.....24-35
Mid/High Fire Kilns
 (Cone 5-8)54-59, 70-75
Modeling and Decorating Wheel80
Modeling Clays.....82-84
Modeling Materials.....82-85
Modeling Tools.....76
Moist Clay.....5-7, 82-84
Mold Making Materials8, 85
- N**
Nail Hole & Corner Filler.....86
- O**
Ordering Information89
- P**
Papier Maché, Instant85
Peephole Plugs.....65
Permoplast Clay84
Pins, Element.....66, 68
Plaster, Pottery.....85
Plasti-Bat40
Plastic Bag8
Plast-i-Clay84
Plate Setter64
Pointed Stilts.....64
PolyBlade.....81
Polymer Clay Tools81
PolyRoller81
Pony Roller76
Potter's Stool40
Potter's Wheels37-39, 48-49
Pottery Brushes.....80
Pottery Plaster85
Pottery Tool Kit.....76
- R**
Roller, Pony76
Rollers, Slab42-43
Rollers, Textured Clay78-79
Rubber Latex.....8, 85
Rub 'n Buff.....87
- S**
Safety Information89
Sculptamold.....85
Sculpting Tools76
Select Fire Automatic Kilns50-59, 70-75
Select Fire Kiln Control60
Select Fire Wall Mount.....60
Select Fire with Zone Control60
Setter for Plates.....64
Shelf Supports64
Shelf Wash, Kiln65
Shelves, Kiln.....63
 Carts.....46, 62
Slab Rollers42-43
Slip Trail Applicator.....81
SmartCart.....45
Splash Pans41
Stilts, Pointed64
Stonex Modeling Clay.....82
Stool, Potter's40
SuspendAid36
- T**
Textured Clay Rollers.....78-79
Texturizers.....23, 34-35
Thermocouples61
Tile Clay Cutters77
Tiles, Bisque36, 80
Tools76-81
Trimming Tools.....77
- U**
Underglaze Applicator36, 81
Underglazes.....9-15
 Chalk Crayons.....15
 Liquid (LUG)12-13
 Pencils15
 Semi-Moist Pans.....14
 Temperature/Color Variation Charts9, 13
 Velvets (V) [4 NEW COLORS]9-11
- V**
Velvet Underglazes [4 NEW COLORS]9-11
Vents, Kiln.....62
- W**
Ware Cart EX.....47
Wax Resist Solution36
Wheel, Decorating80
Wheels:
 Comparison Chart48-49
 Electric.....37-39, 48-49
 Modeling and Decorating80
 Wire Clay Cutter.....77
Wood Finishing Products86-87
- Z**
Zone Control (EXCEL Kilns)60

HOW TO ORDER OUR SAFE PRODUCTS



We Certify that We Ship Lead Free Products in Compliance with the Consumer Product Safety Improvement Act of 2008 (CPSIA)

As a family-owned company since 1919, it has been our mission to develop safe products with safe-labeling procedures for the highest safety standards in both schools and studios. We have built a state-of-the-art digital databank to produce Certificates of Conformity for all products shipped in compliance with the Consumer Product Safety Improvement Act of 2008. This Act mandates that all products manufactured for use by children be certified lead-free. Distributors of AMACO products may contact us to obtain Certificates of Conformity for all shipments.



All AMACO products are certified by the Art & Creative Materials Institute (ACMI) and adhere to safe labeling guidelines.

After our Ceramics Laboratory formulates safe products, they are sent to Duke University Medical consulting toxicologists for product evaluation. Toxicological screening includes evaluation of raw materials, product safe-use instructions, labeling, and considers the possible misuse of product. Adherence to all federal and state regulations are met as well as new Art & Creative Materials (ACMI) guidelines, which keep pace with new research and studies on product safety. Appropriate testing on products, raw materials and their packaging is performed by Kirby Memorial Health Center (an ILAC certified laboratory) before final certification by ACMI. Since 1940, ACMI has managed a certification program for art materials which assists end users in determining which products are appropriate for their use based on safety considerations. AMACO is proud to be one of the original members of ACMI and works closely within the group to assure that product safety is always a prime consideration.



We comply with UL standards for electrical manufacturing of kilns to ensure public safety and prevent environmental emissions.

Since 1894, Underwriters Laboratories (UL) has been testing, verifying, validating and inspecting thousands of everyday things to keep your family safe. As an independent product safety certification organization, UL has no affiliation with a brand, product or company—their only concern is your safety. Toward that end, we also comply with cUL international standards for electrical safety on all kilns.

Safety Data Sheets (SDS)

AMACO® offers SDS sheets on all products we sell, including those we distribute. If you do not see the SDS sheet you need on our website (amaco.com), call our Technical Services Department and we will fax a copy to you.

Warranty Terms are limited on equipment.

brent® potter's wheels and equipment and EXCEL® kilns are covered by warranties limited to defects in materials and workmanship during manufacturing process. Components we purchase for equipment are covered only by those manufacturer's warranties. Validity of all claims is at discretion of AMACO/brent.

AMACO/brent Product Liability is Limited.

AMACO/brent products may be replaced if proven to be defective in manufacturing or packaging. Except for such replacement, our products are sold without additional liability, even though defect may have caused damage or loss.

Prices

Prices in this Catalog No. 124 are Manufacturer's Suggested Retail Prices for 2024 only. Prices are subject to change without notice. Prices for special wiring for foreign countries is available upon request. We apologize for any inconvenience caused by typographical errors in prices; customers will be billed intended price and may accept or refuse purchase.

Packing and Freight Routing

We do not charge for packing and crating domestic orders, but do charge time and materials on those requiring pallets. We also charge time and materials for special packing or wood crating on international orders. Our routings are carefully selected and offer the lowest prices; customer-specified routing is possible only when feasible. Tariff regulations include sidewalk delivery only, however we can quote charges for lift-gate and inside delivery options to be included on one shipping invoice. When shipping to locations without receiving facilities, additional minimal charges may be added. Insurance charges on parcel post shipments will be charged to the customer.

ShockWatch® Program for Kilns

AMACO/EXCEL kilns are shipped with ShockWatch® Impact indicators. An activated RED means the product was handled roughly and damage to the kiln may have occurred. Note activation on delivery receipt then inspect for damage. If damaged, leave in original container and request immediate inspection from carrier within three (3) business days. If ShockWatch® indicator is not activated, but damage is found, contact AMACO within seven (7) days. Leave in original container or if already removed, keep original container for inspection.

Over, Short or Damaged Shipments

Shortages MUST be reported within 30 days to be allowed on either freight bill charges or packing shortages. Freight bill shortages MUST be noted on the delivery receipt. Packing shortages must be reported directly to us. When damage (concealed or exposed) occurs: Note exposed damage to delivering driver on delivery ticket; note must be signed by driver and receiving agent. If possible, examine concealed contents for possible damage and note as well; claims for concealed damage must be filed within 9 months. Overages must be reported to AMACO for disposition instructions.

Returned Goods

Merchandise can be authorized for return when it is defective or an error on our part. Full credit can be given only with a 'Returned Goods Authorization Tag' available by calling 800-374-1600 or e-mailing shipping@amaco.com. If the error was not ours, customers will be charged a 15% restocking fee on the net price and transport costs. All credit is based on successful return of merchandise.

Terms and Freight Charges

Payment should accompany each order unless credit arrangements have been made in advance. Payments should include charges for parcel post, UPS and freight shipments. Shipping charges are determined by weight, size and destinations; so we cannot quote shipping charges when orders are placed. We accept Visa, MasterCard, and Discover. Wire transfers are also accepted on International orders. Cashier's check or money orders are collected on C.O.D shipments. Credit for overpayment will be applied against your next order.



American Art Clay Co., Inc.
6060 Guion Road, Indianapolis, IN 46254
Phone: (317) 244-6871 or (800) 374-1600
email: salesupport@amaco.com
www.amaco.com

International Operations:
email: exportsales@amaco.com
USA Tel: (317) 683-1300

RESOURCES 
CLAY

RESOURCES 
CREATE



American Art Clay Co., Inc.
6060 Guion Road
Indianapolis, IN 46254
www.amaco.com

Part No. 11875B

RESOURCES 
FIRING

RESOURCES 
GLAZE